

Twenty by/Six



OUR VISION

Redefining, Elevating and Transforming the Downtown Workday

Time is our greatest luxury. At Twenty by Six we've designed a working environment with the convenience and amenities of a large mixed-use campus coupled with the intimacy of a boutique office building. With lush outdoor commons, ample outdoor workspace and a thoughtful collection of on-site amenities, Twenty by Six brings together the essentials for employee health, productivity and daily quality of life – all in the heart of downtown San Diego.

[Click Here to Take a
Virtual Tour of the Project](#)



RE-IMAGINED

364,140

RENTABLE SQUARE FEET

1

SPACIOUS OPEN AIR
COURTYARD

2021

DELIVERY OF A FULLY
RE-IMAGINED CAMPUS

100+

WALKABLE DESTINATIONS FOR
DINING, DRINKS & DIVERSION



20/6 offers two distinct experiences in one holistic campus: a 20-story north tower and a new ground up 6-story south tower.

Set on a prime city block between 4th, 5th, A and B Streets in downtown San Diego's central business district, the Twenty by Six campus offers two unique office buildings - a fully re-imagined 20-story tower and a new ground-up 6-story tower designed by Gensler Architecture.

THE CONCEPT

Designed for Workplace Wellness



Twenty

20 Floors

OF NEWLY AMENITIZED CLASS
A OFFICE TOWER

STATE-OF-THE-ART
CONFERENCING CENTER FOR
SMALL OR LARGE GROUPS

Premium Visibility

DOWNTOWN'S **LARGEST** BUILDING
TOP SIGNAGE OPPORTUNITY

FITNESS CENTER WITH
YOGA & PELOTON STUDIO

Full Floor Opportunities

EFFICIENT SIDE CORE WITH
COLUMN-FREE FLOOR PLATE

SPA-STYLE SHOWERS &
LOCKER ROOMS

Six

6 Floors

OF CLASS A NEW
CONSTRUCTION

EXCLUSIVE OUTDOOR
WORKSPACE ON EVERY FLOOR

Premium Visibility

PROMINENT SIGNAGE
OPPORTUNITIES

FLOOR-TO-CEILING GLASS
EXTERIOR

Efficient

CORE FACTOR

ACTIVATED PLAZA
WITH CAFÉ

THE NEIGHBORHOOD

Where Work Comes to Life

Situated within the downtown business core, Twenty by Six is an 8-minute walk, drive, ride share, or pedicab ride from some of San Diego's most dynamic destinations for arts, culture, and restaurants.

Enjoy an unparalleled workday location where an effortless reverse commute, a vibrant nightlife, and ample mouthwatering experiences of every flavor are just a few quick steps away.

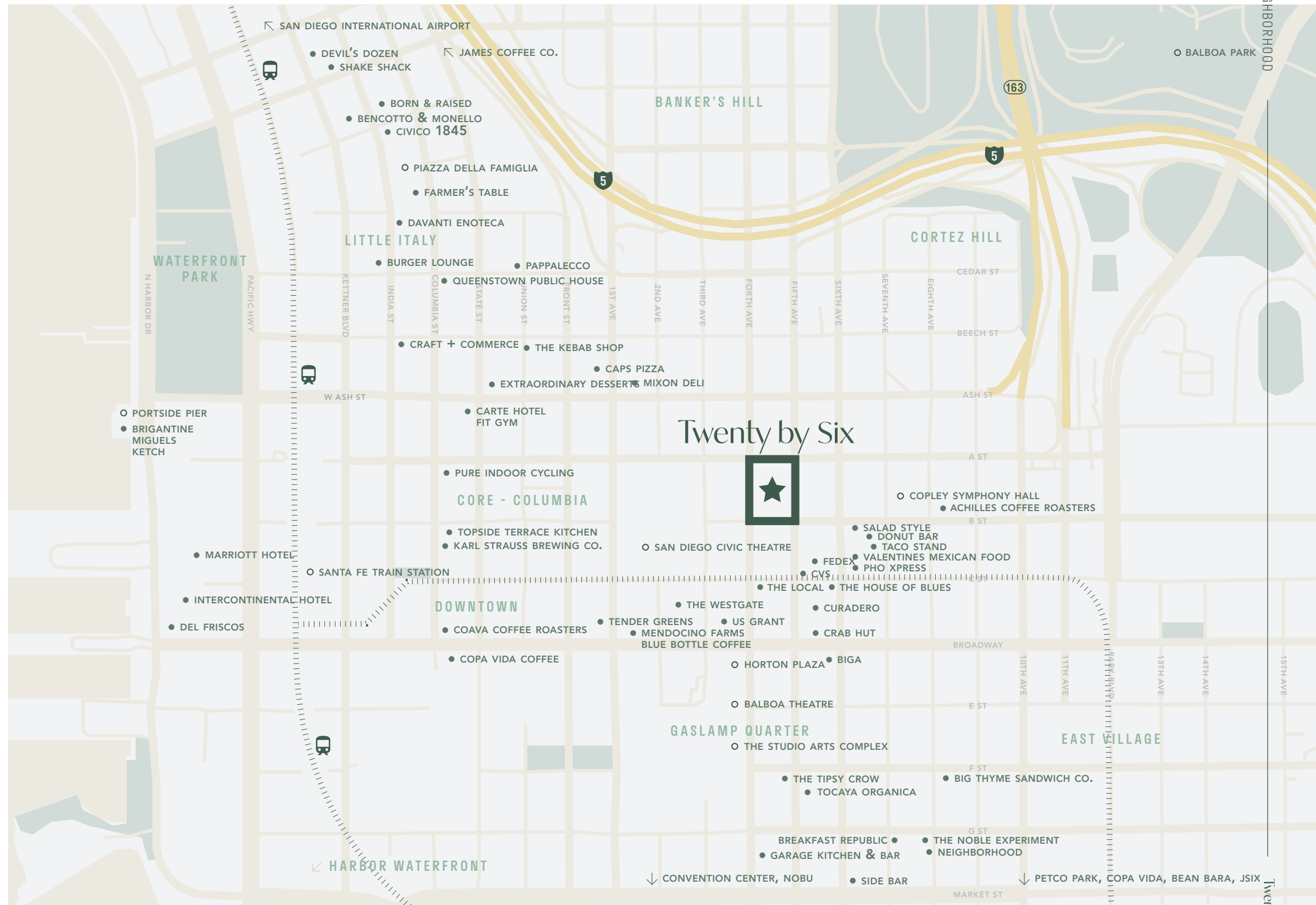



Centrally Located and Conveniently Connected

Walk over to East Village where a burgeoning cultural hub is alive with craft beer gardens, food trucks, and music. Make your way down to the Gaslamp Quarter for rooftop bars, fine dining, and endless people watching.

Bounce over to Little Italy for authentic, soul-warming Sicilian. Wander through scenic Balboa Park on your lunch break and soak up the serenity.

5

MINUTES TO LITTLE ITALY WITH CIRCUIT

25

RESTAURANTS FOR FRIDAY DATE NIGHT WITHIN WALKING DISTANCE

6

SMALL PLATES SHARED AMONG CO-WORKERS AT TOCAYA ORGANICA

20+

DAILY DONUT FLAVORS THREE BLOCKS AWAY

5

MINUTES TO PETCO PARK

8

CLASSIC SUMMER MOVIES AT THE ROOFTOP CINEMA CLUB

TWENTY BY SIX | THE AVAILABILITIES

450 B ST

SUITE	SF	AVAILABLE	CONDITION
200	13,919 (Divisible)	Vacant	Spec
*325	4,885	Vacant	Spec
*350	1,880	Vacant	Spec
**400	15,185	Vacant	Shell
**500	15,289	Vacant	Shell
**600	15,237	Vacant	Shell

* 3rd Floor Spec Suites contiguous for up to 6,765 RSF
 **Full floors 4-6 available contiguous for 75,411 RSF

451 A ST

SUITE	SF	AVAILABLE	CONDITION
*600	2,869	Vacant	2nd Gen
*610	2,412	Vacant	Spec
*620	1,921	Vacant	2nd Gen
*650	5,962 SF	Vacant	2nd Gen
720**	2,445	Vacant	Spec
740**	3,205	Vacant	Spec
750	2,791	Vacant	Spec
780	2,396	Vacant	2nd Gen
1500	14,429	Vacant	Excellent 2nd Gen
1900	14,025	Vacant	Shell
2000	15,315	Vacant	2nd Gen

* 6th Floor Suites contiguous for up to 13,164 RSF
 ** Suites 720/740 contiguous for 5,650 RSF



SIX | 450 B ST | THE FLOOR PLANS



2nd

SINGLE TENANT
SUITE 200 // 13,919 RSF

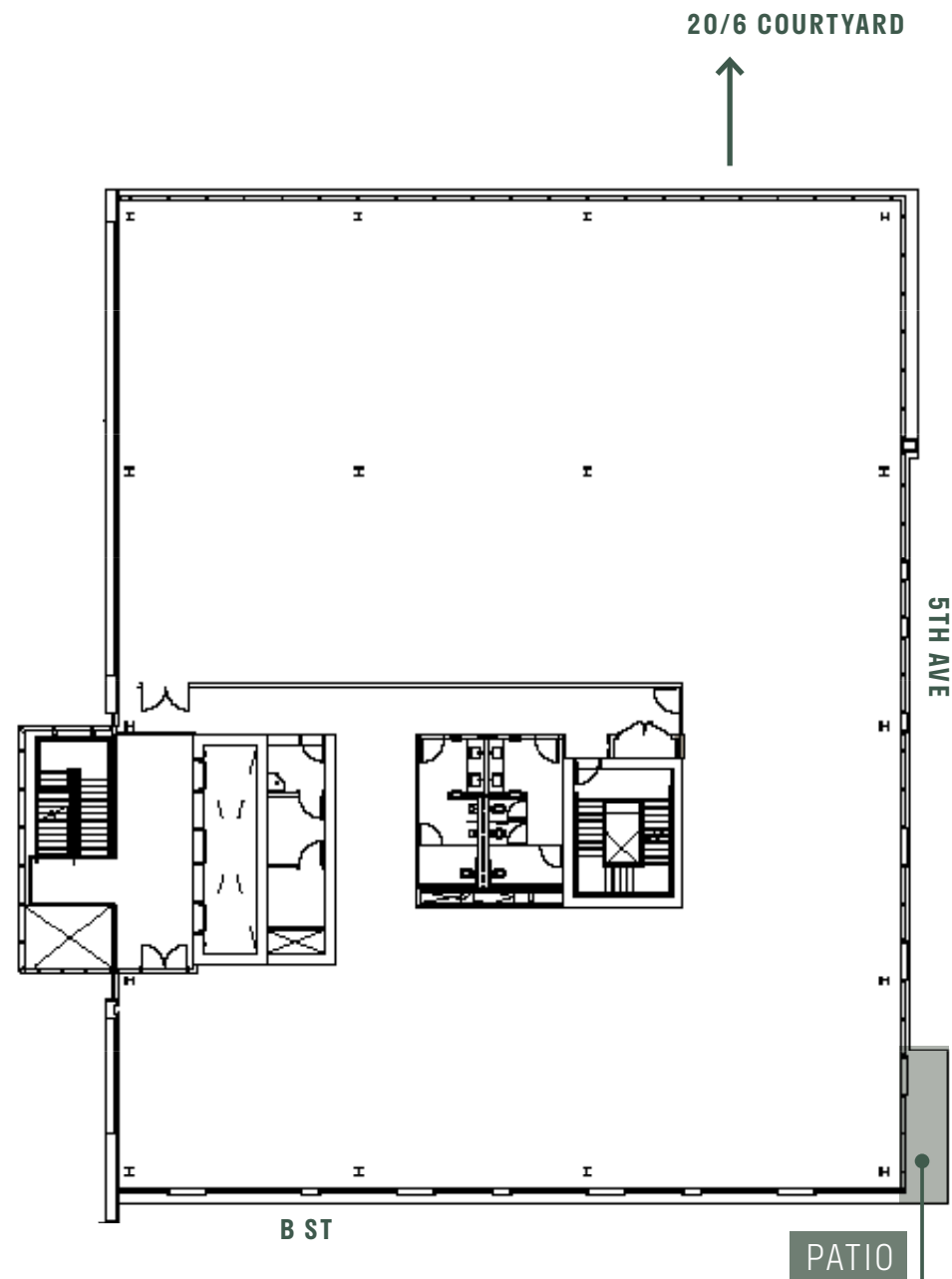

2nd

HYPOTHETICAL SPEC SUITE PLAN
SUITE 200 // 4,842 RSF

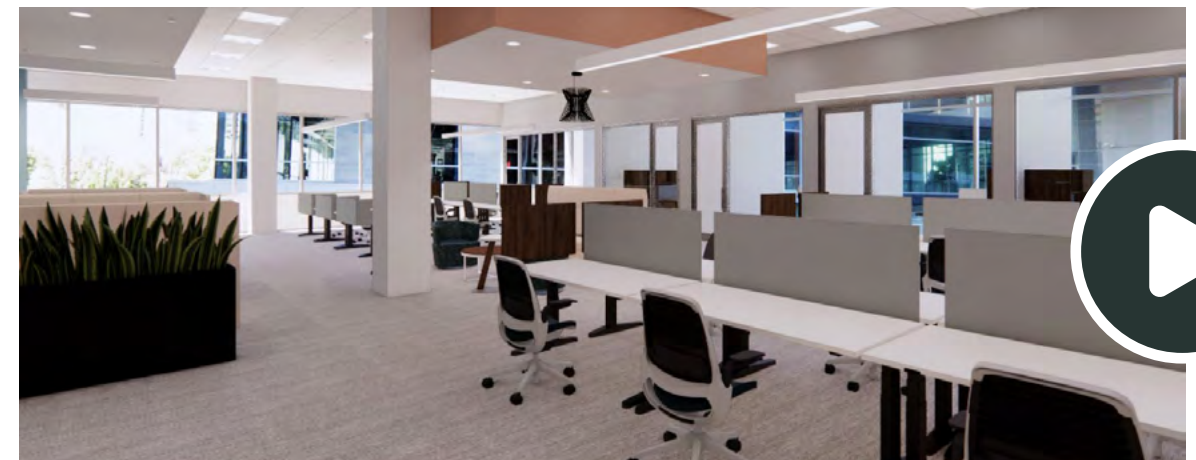
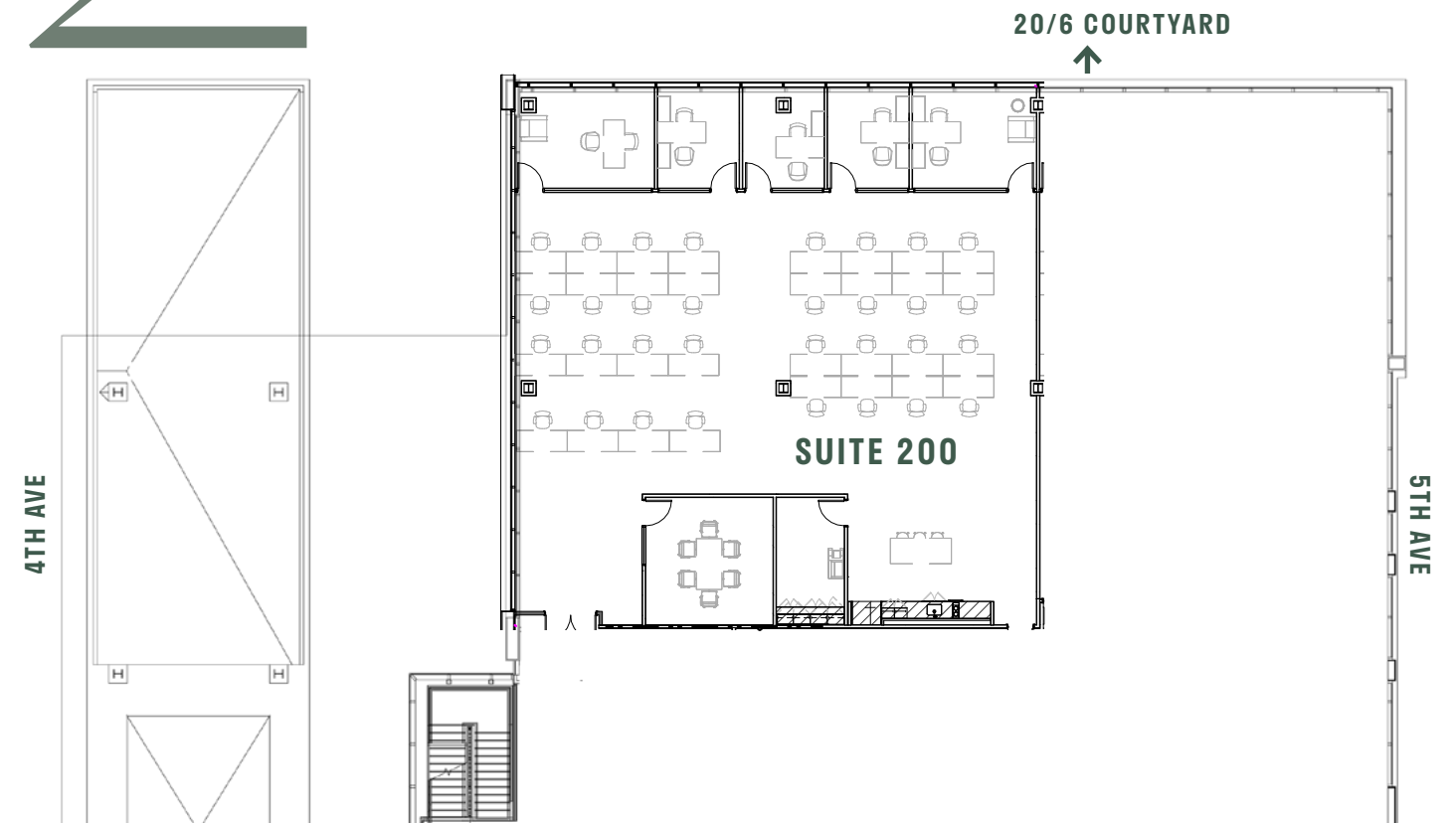

SIX | 450 B ST | THE FLOOR PLANS

2nd

HYPOTHETICAL SPEC SUITE PLAN
SUITE 225 // 2,877 RSF

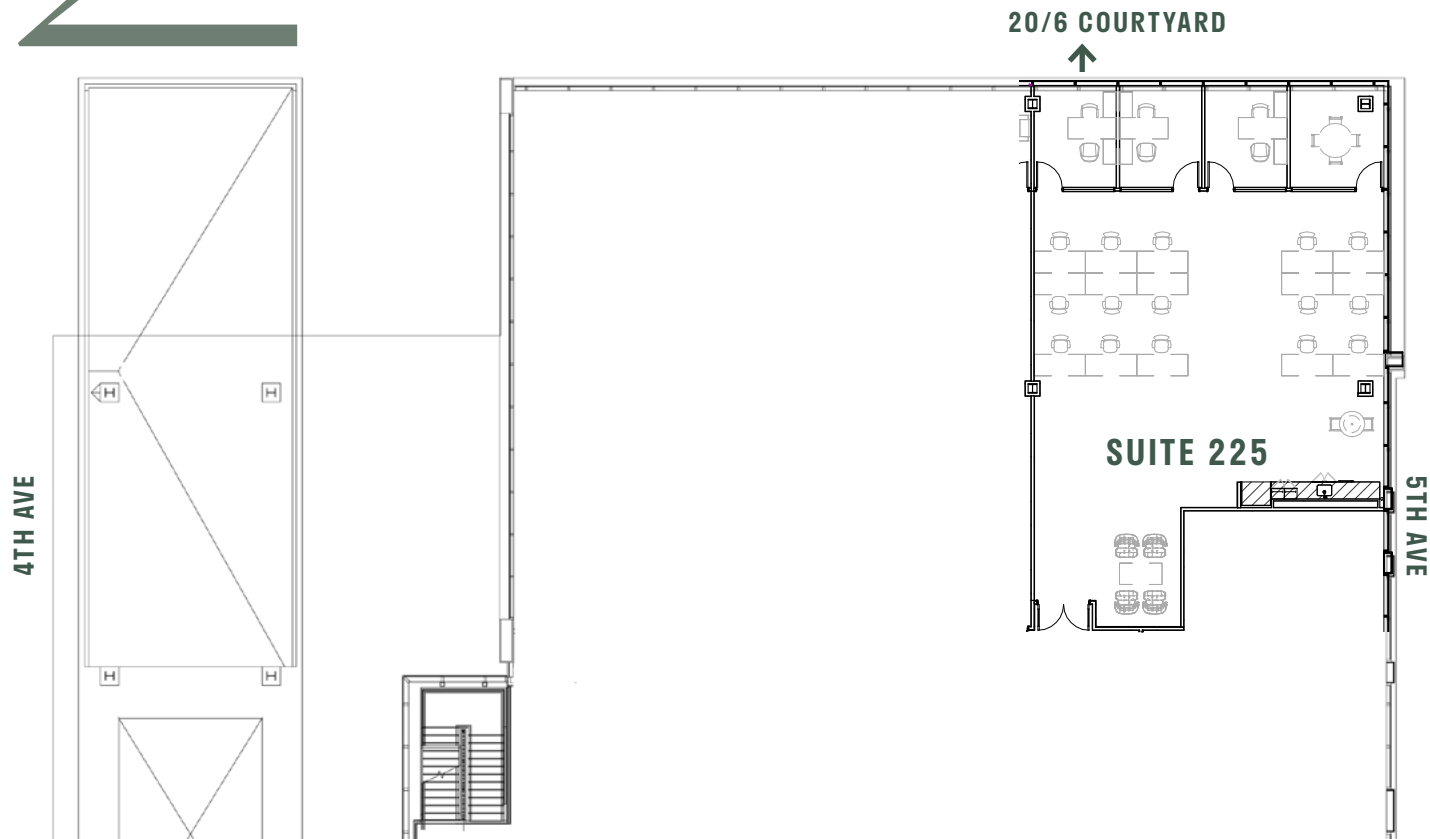

SIX | 450 B ST | THE FLOOR PLANS

2nd

HYPOTHETICAL SPEC SUITE PLAN
SUITE 250 // 6,200 RSF

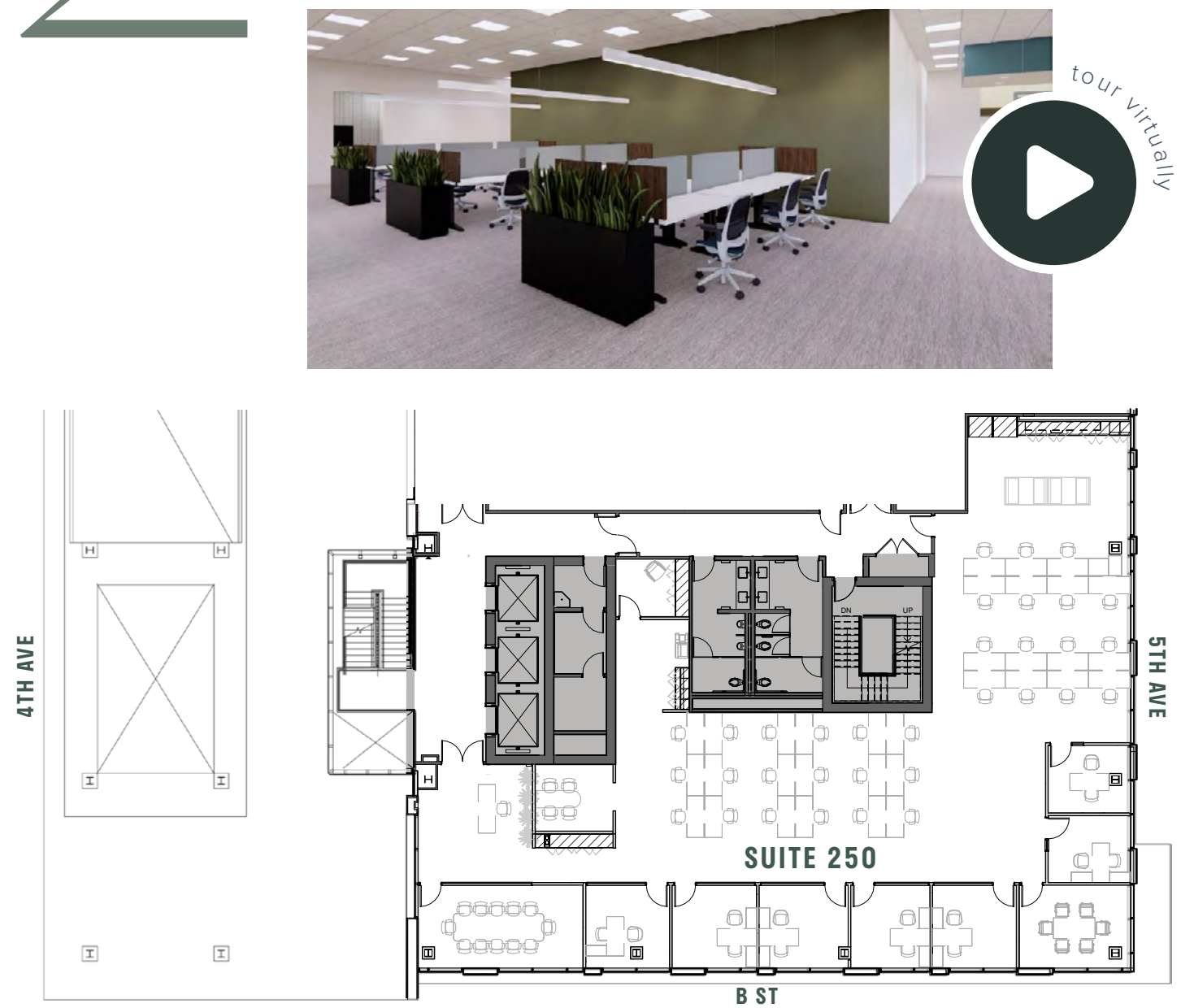

3rd

SPEC SUITE

SUITE 325 // 4,885 RSF + APPROX. 1,600 SF PATIO

NOTES

Brand New Spec Suite. 8 private offices, 1 executive office/breakout room, 1 conference room, break area, open office and approximately 1,600 SF private ensuite patio.



20/6 COURTYARD



PRIVATE OUTDOOR PATIO

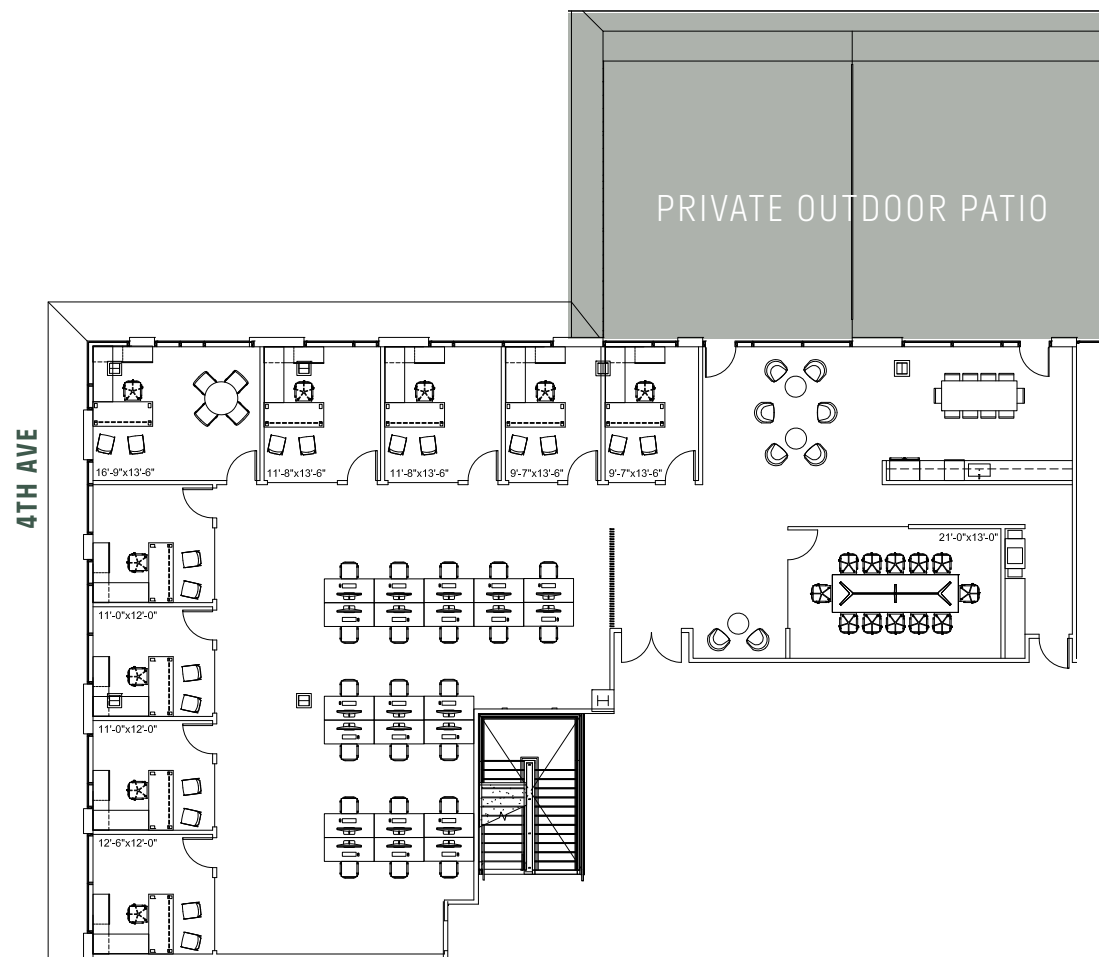

3rd

SPEC SUITE

SUITE 350 // 1,880 RSF

NOTES

Brand New Spec Suite. 3 private offices, conference room, break area & open office.

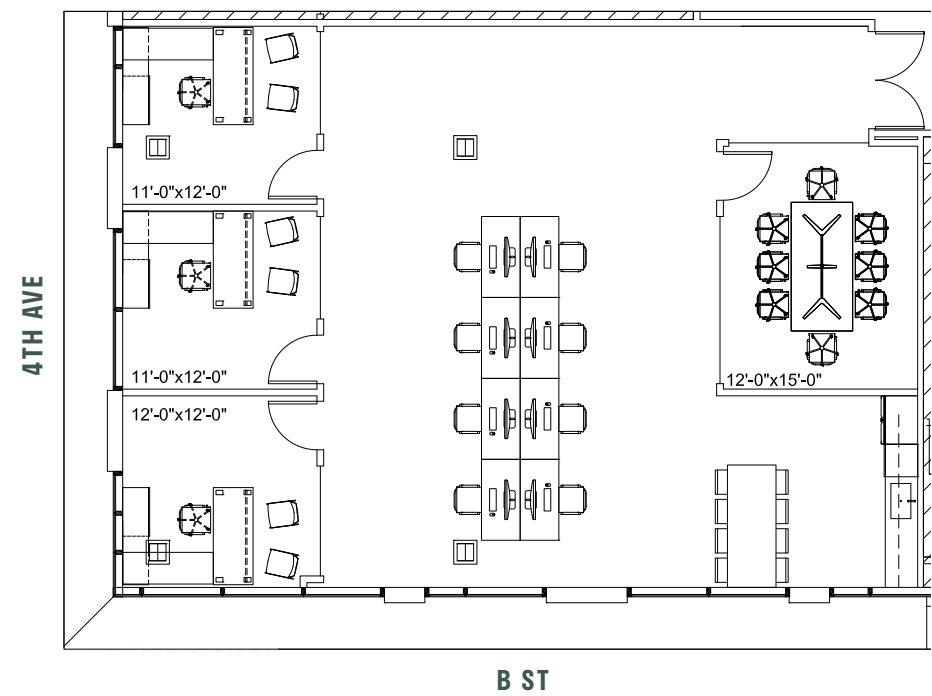

3rd

SPEC SUITE

SUITE 325 & 350 // CONTIGUOUS UP TO 6,765 RSF + APPROX. 1,600 SF PATIO

NOTES

Brand New Spec Suites. 11 private offices, 1 executive office/breakout room, 2 conference rooms, 2 break areas, open office and approximately 1,600 SF ensuite patio.

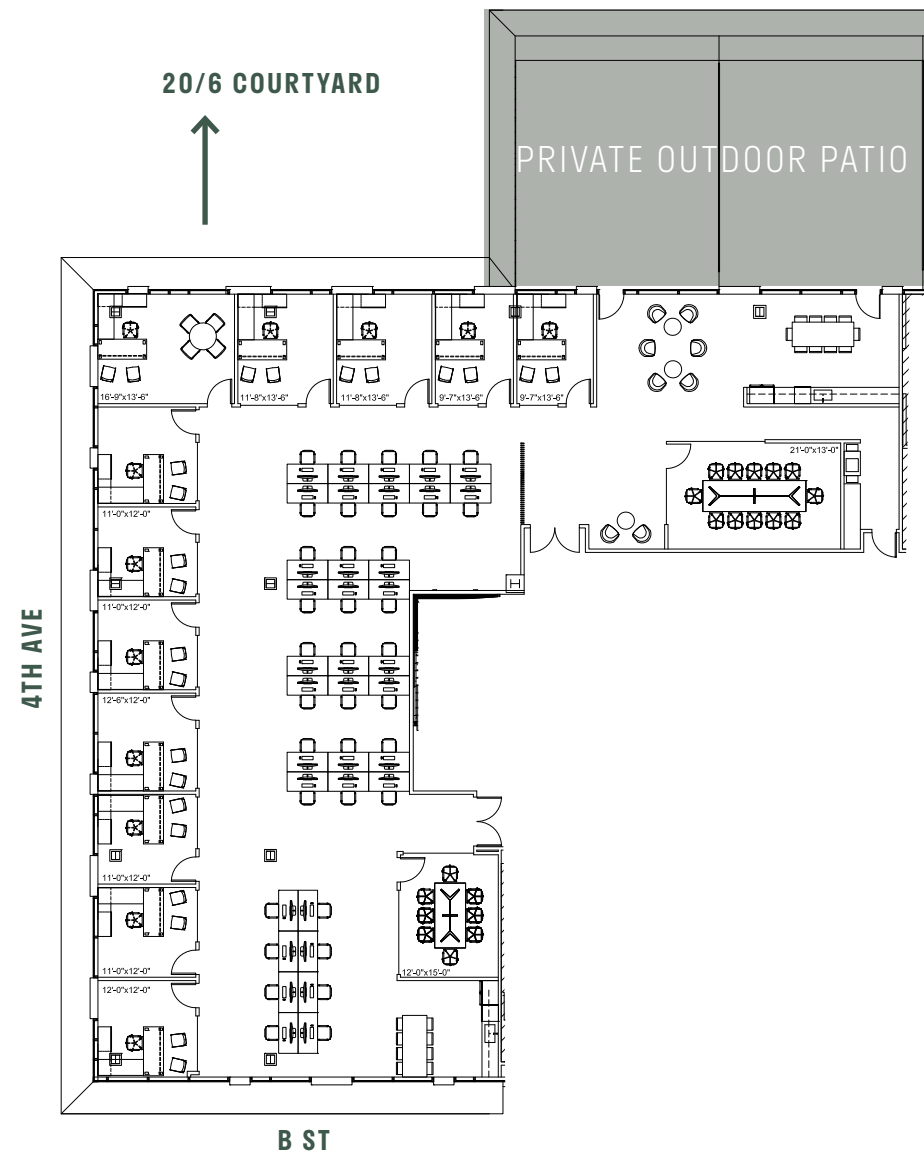

SIX | 450 B ST | THE FLOOR PLANS

4th

SINGLE TENANT
SUITE 400 // 15,185 RSF

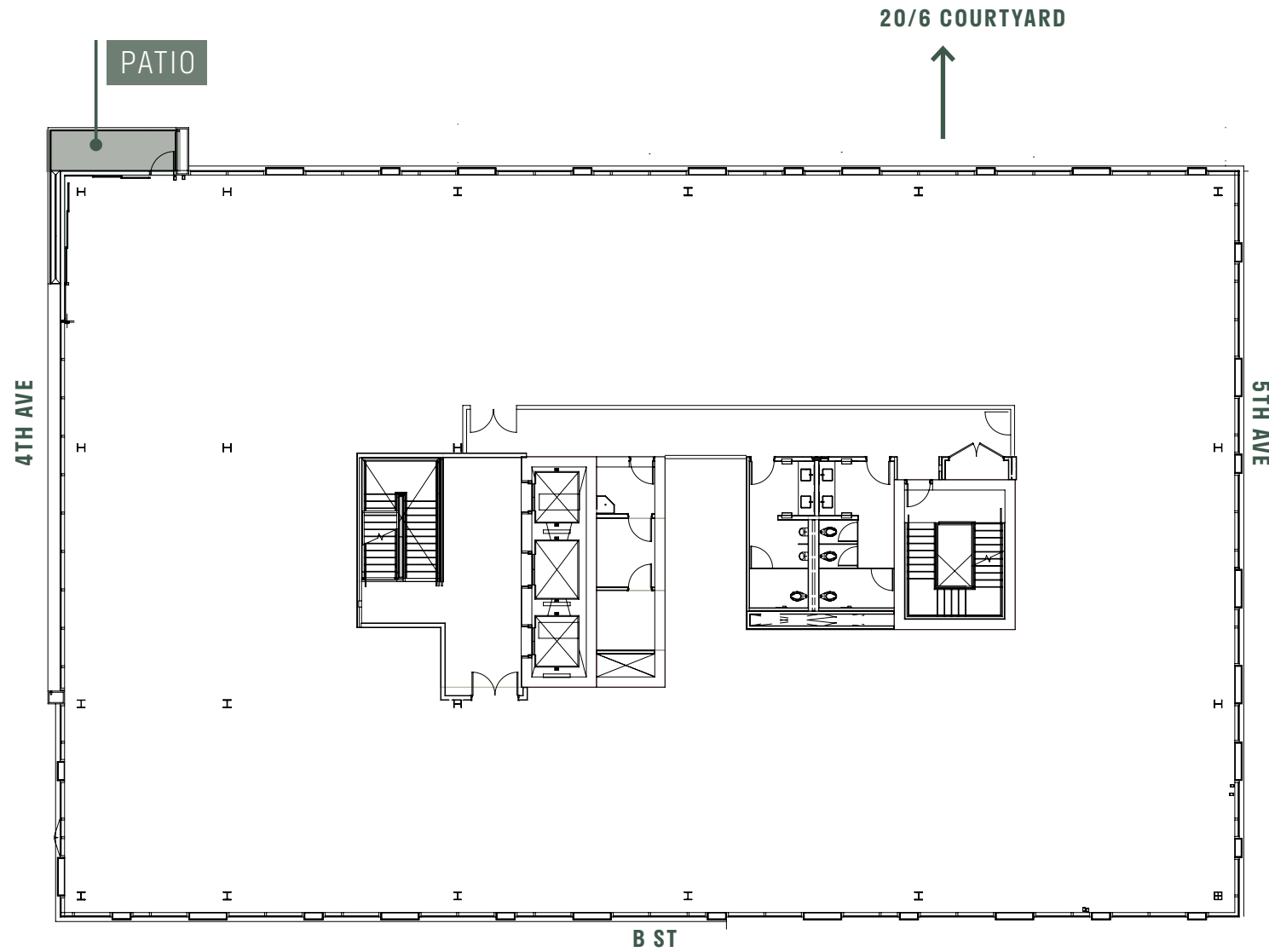

SIX | 450 B ST | THE FLOOR PLANS

5th

SINGLE TENANT
SUITE 500 // 15,202 RSF

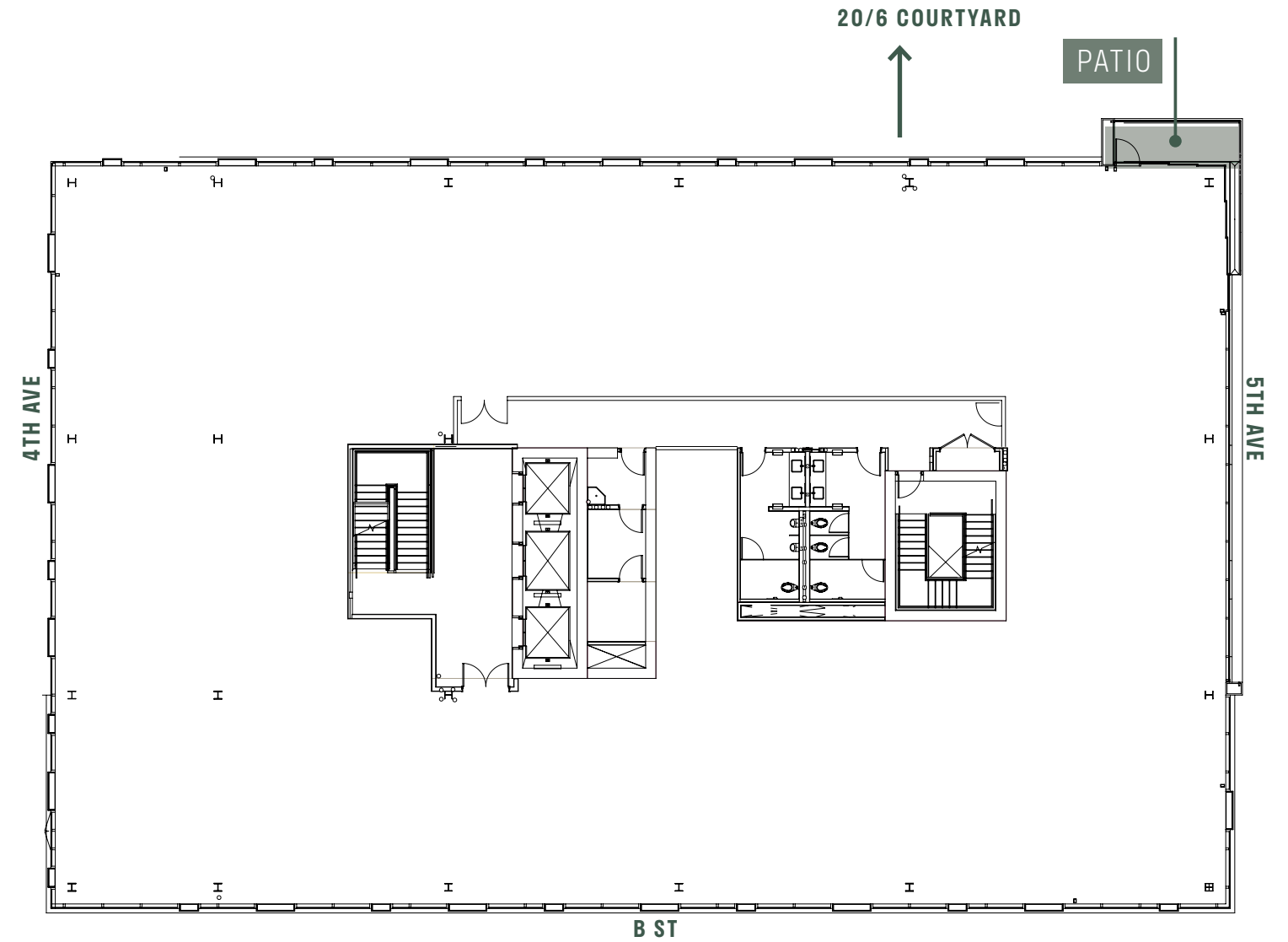

SIX | 450 B ST | THE FLOOR PLANS

6th

SINGLE TENANT
SUITE 600 // 15,237 RSF

20/6 COURTYARD

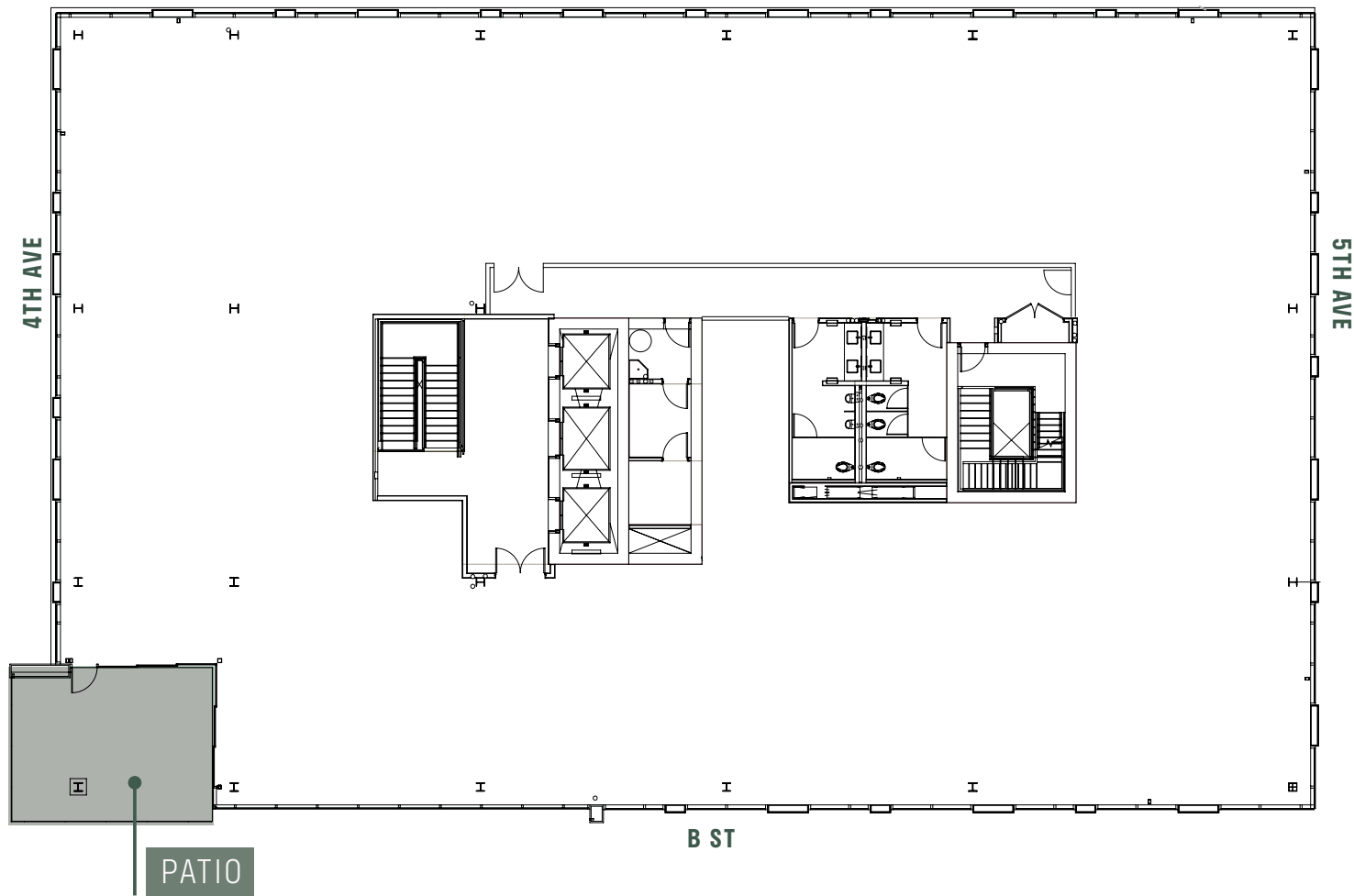

FULL FLOORS 4-6 AVAILABLE CONTIGUOUS **45,711** RSF

TWENTY | 451 A ST

TWENTY | 451 A ST | THE FLOOR PLANS

6th

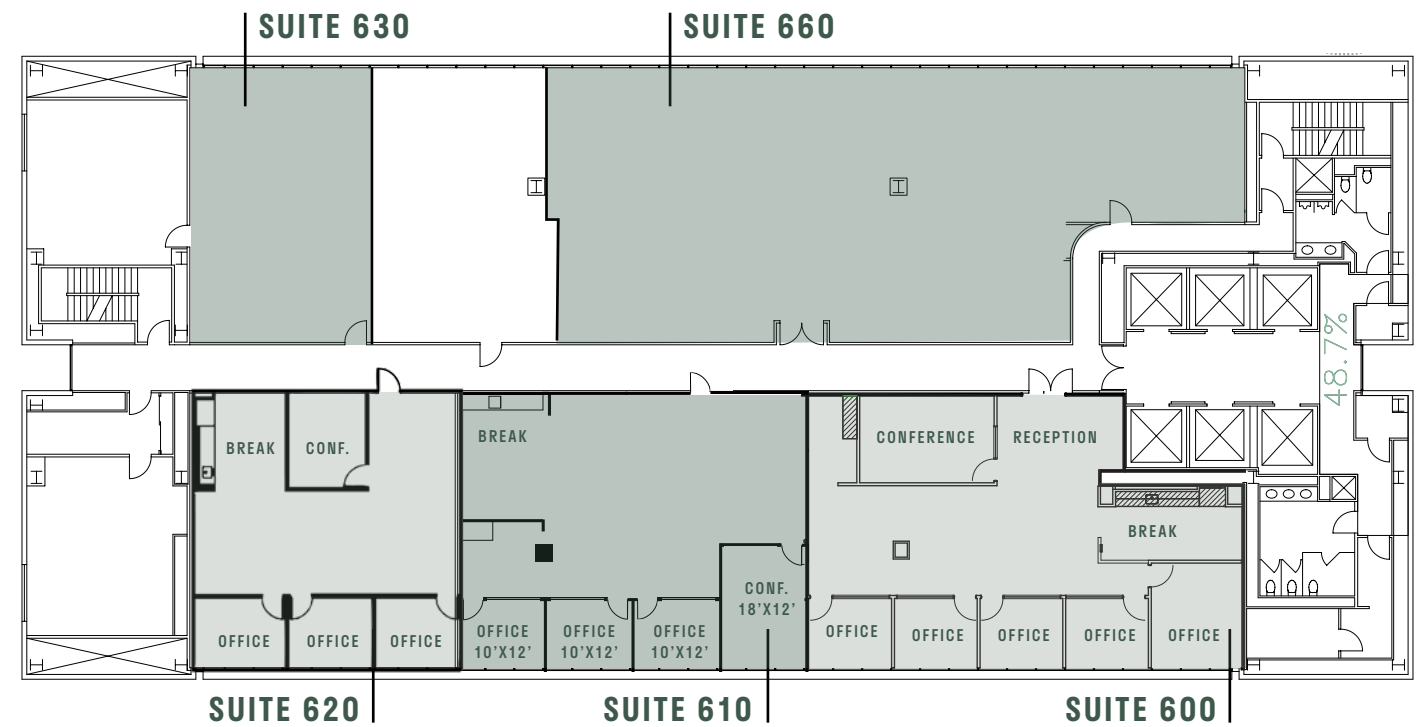

SUITE	SF	STATUS	CONDITION	NOTES
600	2,869	Vacant	2nd Gen	Reception, 5 private offices, conference room, break room and open office area
610	2,412	Vacant	Spec	Move in Ready Spec Suite. 3 private offices, conference room, break area and open office
620	1,921	Vacant	2nd Gen	3 private offices, conference room, break area and open office
630	~1,000	Vacant	2nd Gen	Approximately 1,000 SF 2nd gen space. Pending new measurements
660	~4,962	Vacant	2nd Gen	Approximately 5,000 SF 2nd gen space. Pending new measurements
CONTIGUOUS OPTIONS				
Partial Floor	13,164	Vacant	Partial floor available contiguous. Offering flexible options for ±5,000 SF, ±10,000 SF and ±13,000 SF tenants	



7th

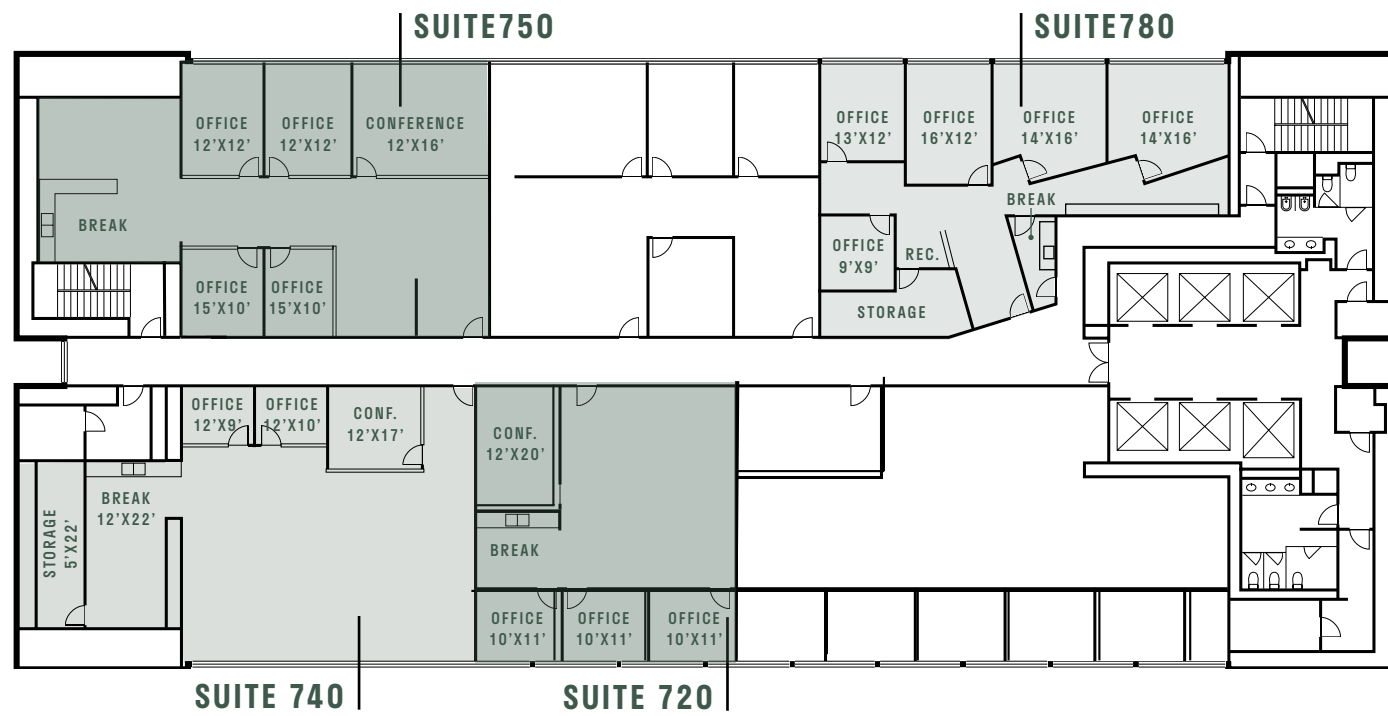

SUITE	SF	STATUS	CONDITION	NOTES
720	2,445	Vacant	Spec	Move in Ready Spec Suite. 3 private offices, conference room, break area and open office
740	3,205	Vacant	Spec	Move in Ready Spec Suite. 2 private offices, conference room, break area, storage and open office
750	2,791	Vacant	Spec	Move in Ready Spec Suite. 4 private offices, conference, break area and open office
780	2,396	Vacant	2nd Gen	Reception, 5 private offices, conference room, storage and break area.



CONTIGUOUS OPTIONS				
720/240	5,650	Vacant	Spec Suites 720 & 740 available contiguous	

15th

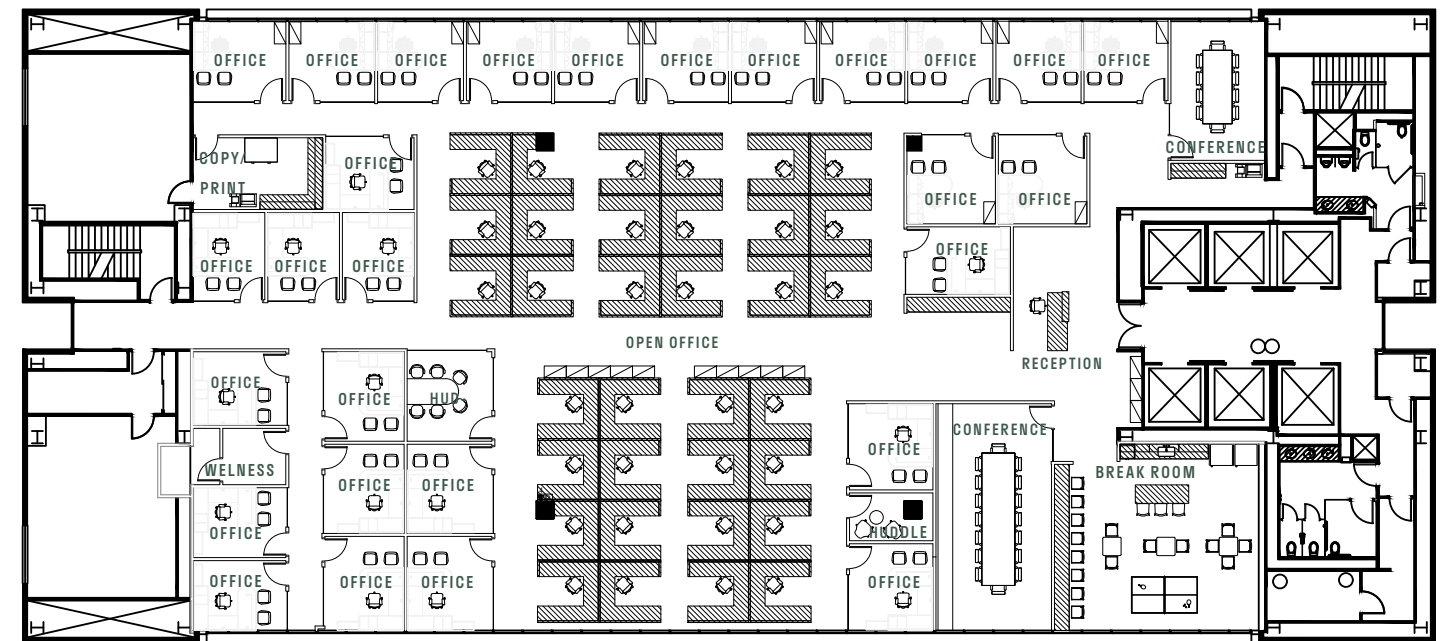

SUITE	SF	STATUS	CONDITION	NOTES
1500	14,429	Vacant	Excellent 2nd Gen	Full floor opportunity. Reception, 27 private offices, 2 conference rooms, break room, wellness room, huddle room, cope/print and large open office

TWENTY | 451 A ST | THE FLOOR PLANS

19th

14,025 RSF

VACANT

*CONTIGUOUS WITH SUITE 2000 FOR 29,340 RSF

**BUILDING-TOP SIGNAGE OPPORTUNITY

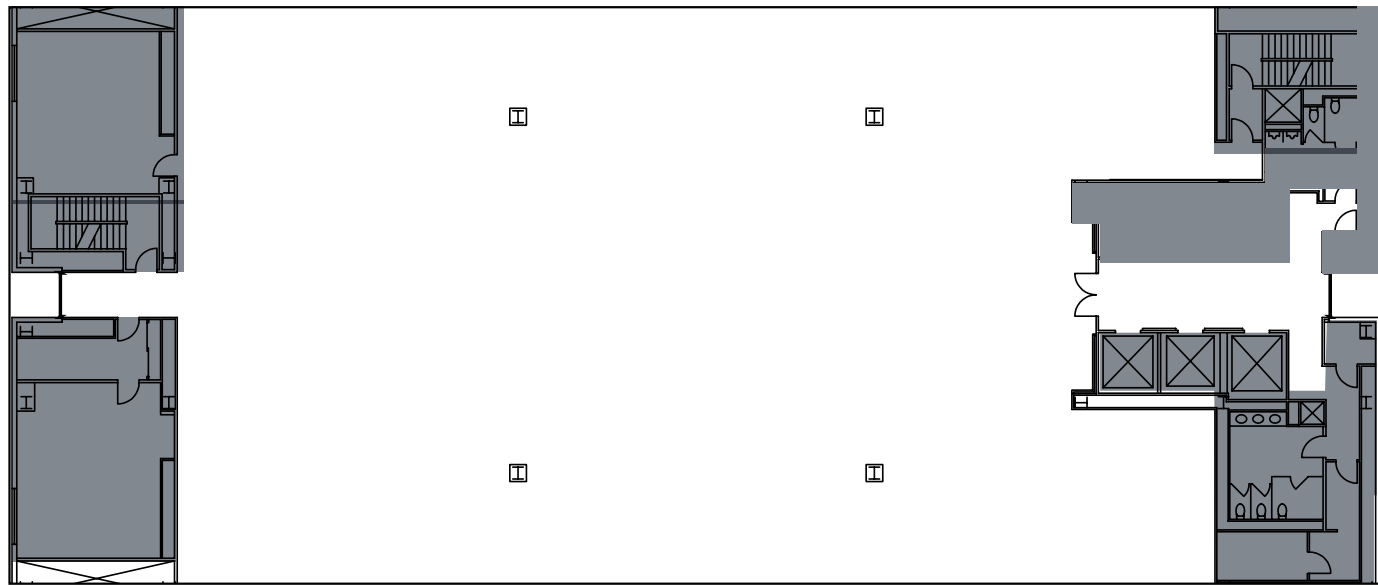

TWENTY | 451 A ST | THE FLOOR PLANS

20th

15,315 RSF

VACANT

*CONTIGUOUS WITH SUITE 1900 FOR 29,340 RSF

**BUILDING-TOP SIGNAGE OPPORTUNITY

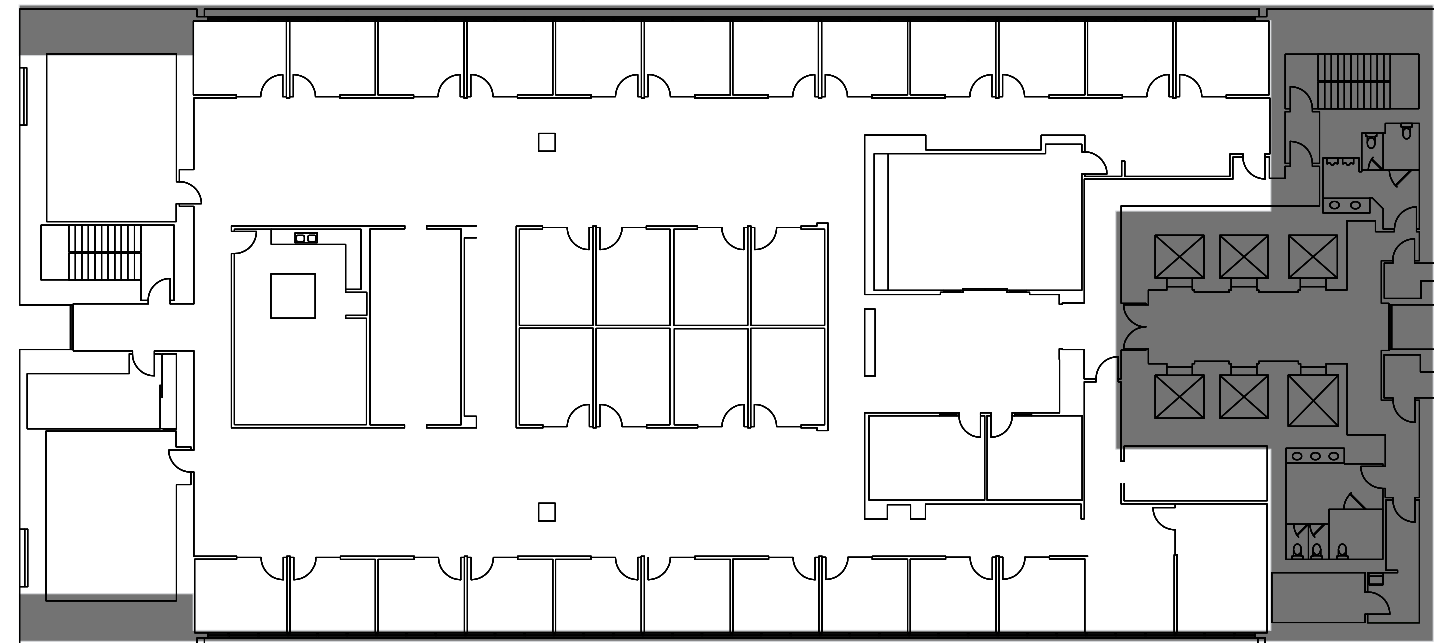



CONTACT US

Leasing



DEREK HULSE

T +1 858 334 4005
derek.hulse@cushwake.com
CA License #01740180

CONNOR WIECK

T +1 858 546 5487
connor.wieck@cushwake.com
CA License #02007940

At Twenty by Six, we've captured San Diego's year-round sunshine and relaxed coastal vibe with architecture that celebrates a truly indoor-outdoor way of life.

Twenty
by/Six