

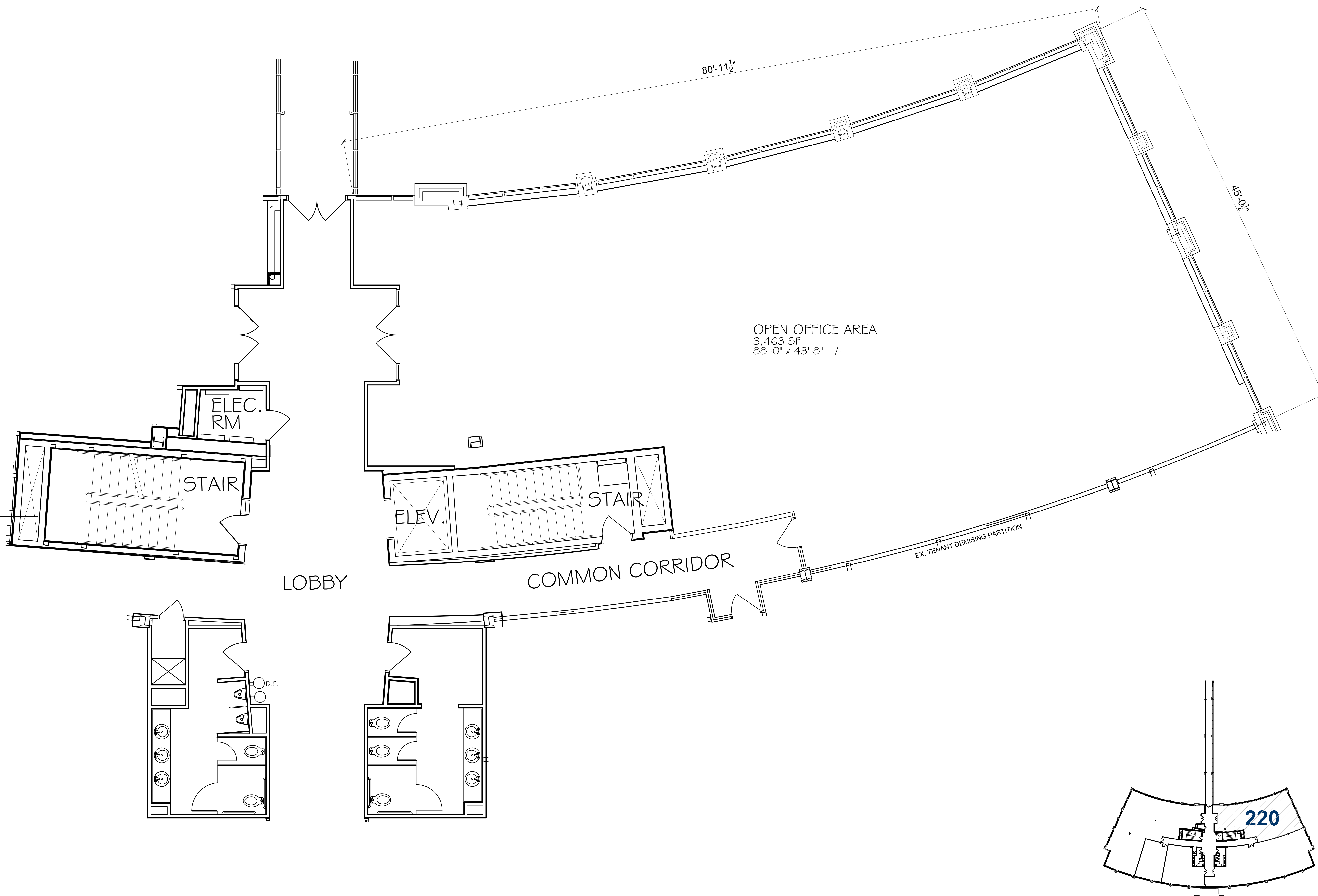

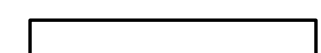





MHAZLET\TSMN\6290 - 6500 Sheridan\02\6290.99.ar02.SECOND FLOOR PLAN.dwg

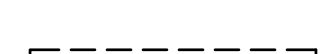
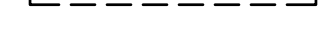

PARTITION PLAN LEGEND

-  EXISTING PARTITION
-  NEW PARTITION
-  PARTITION TO BE DEMOLISHED
-  EXISTING FIRE RATED PARTITION
-  NEW FIRE RATED PARTITION
-  NEW MASONRY PARTITION
-  PARTIAL HEIGHT WALL
-  NEW DOOR AND FRAME
-  EXISTING DOOR AND FRAME
-  EXISTING DOOR & FRAME TO BE REMOVED

GENERAL NOTES

1. ALL FURNITURE, EQUIPMENT AND PLANTS ARE SHOWN FOR SPACE PLANNING PURPOSES ONLY AND ARE NOT SUPPLIED BY UNILAND DEVELOPMENT COMPANY.
2. ALL ARCHITECTURAL ITEMS, AND OR FINISHES NOTED, ARE NOT PART OF THE PACKAGE. ARE AT TENANT'S EXPENSE, AND ARE CONSIDERED UPGRADES TO ENHANCE SPACE ORGANIZATION AND WORK ENVIRONMENT.
3. ALL WORKSTATIONS ARE TO BE PROVIDED AND INSTALLED BY TENANT. FINAL WORKSTATION LAYOUT TO BE APPROVED BY THE BUILDING INSPECTOR PRIOR TO INSTALLATION.

ELECTRICAL PLAN LEGEND

-  TELEPHONE PANEL
-  POWER DISTRIBUTION PANEL AND TRANSFORMER

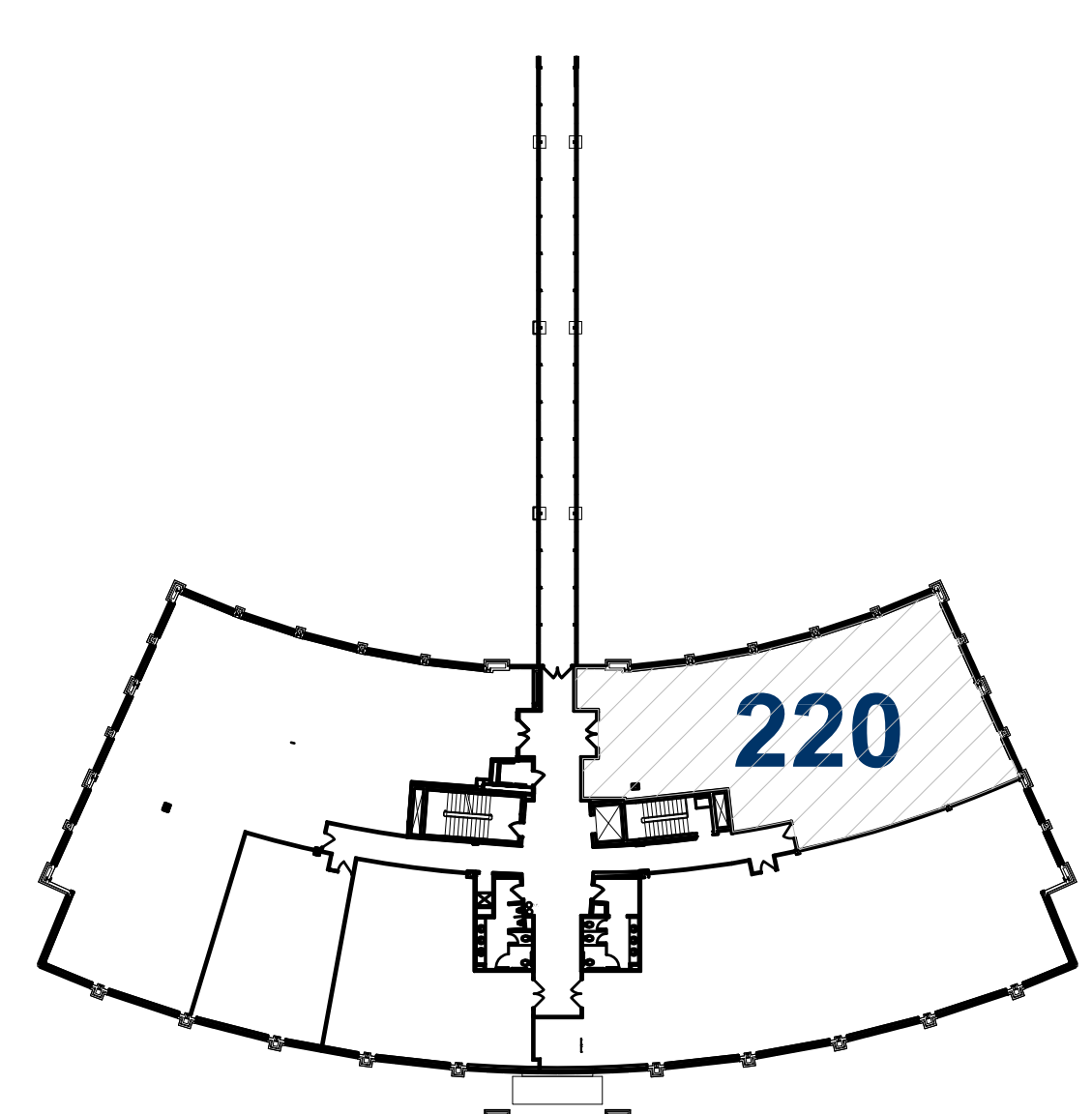

6500 Sheridan Drive Suite 220 | Sheridan Meadows Corporate Park | Amherst, New York

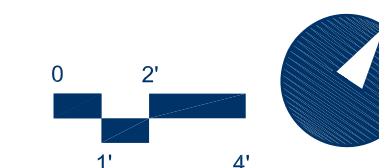

Key Plan 



Second Floor Plan | #6290.99 | 01.15.16

University Corporate Centre | 100 Corporate Parkway | Suite 500 | Amherst, NY 14226-1295 | 716.834.5000 | uniland.com