

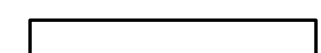





1135.99-af01 - Suite 104.pdf  
mhazlett JV\AIP1135 - 190 Lawrence Bell\1135.99.af01.FLOORPLAN.dwg

### PARTITION PLAN LEGEND

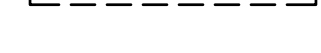
-  EXISTING PARTITION
-  NEW PARTITION
-  PARTITION TO BE DEMOLISHED
-  EXISTING FIRE RATED PARTITION
-  NEW FIRE RATED PARTITION
-  NEW MASONRY PARTITION
-  PARTIAL HEIGHT WALL
- NEW DOOR AND FRAME
- EXISTING DOOR AND FRAME
- EXISTING DOOR & FRAME TO BE REMOVED

### GENERAL NOTES

1. ALL FURNITURE, EQUIPMENT AND PLANTS ARE SHOWN FOR SPACE PLANNING PURPOSES ONLY AND ARE NOT SUPPLIED BY UNILAND DEVELOPMENT COMPANY.
2. ALL ARCHITECTURAL ITEMS, AND OR FINISHES NOTED, ARE NOT PART OF THE PACKAGE. ARE AT TENANT'S EXPENSE, AND ARE CONSIDERED UPGRADES TO ENHANCE SPACE ORGANIZATION AND WORK ENVIRONMENT.
3. ALL WORKSTATIONS ARE TO BE PROVIDED AND INSTALLED BY TENANT. FINAL WORKSTATION LAYOUT TO BE APPROVED BY THE BUILDING INSPECTOR PRIOR TO INSTALLATION.

### ELECTRICAL PLAN LEGEND

-  TELEPHONE PANEL
-  POWER DISTRIBUTION PANEL AND TRANSFORMER

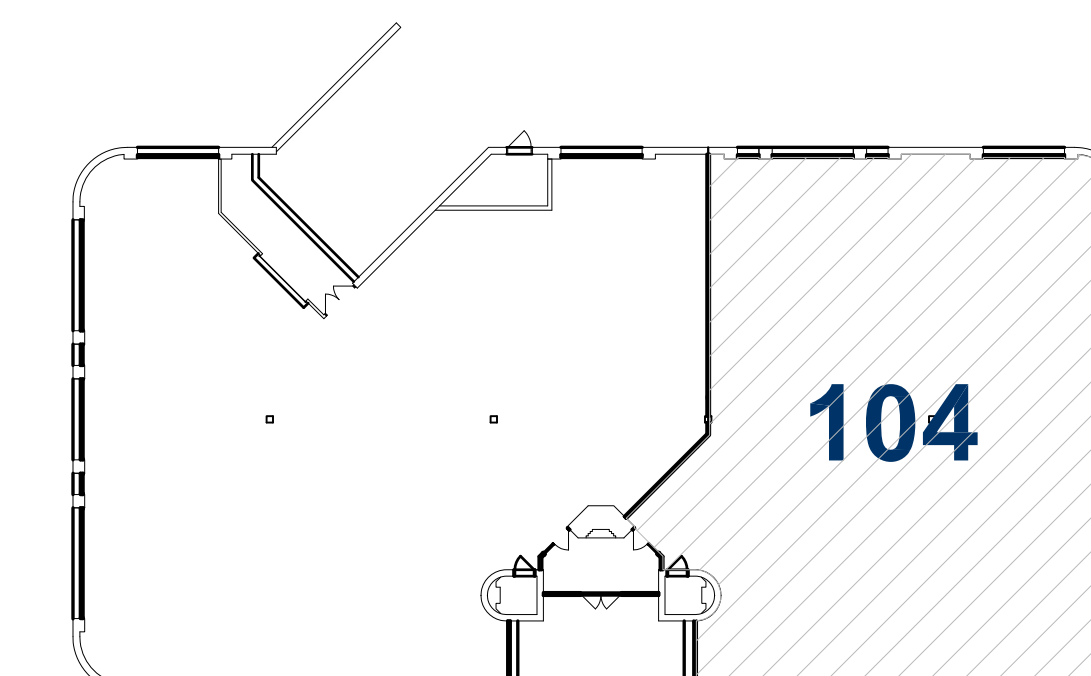
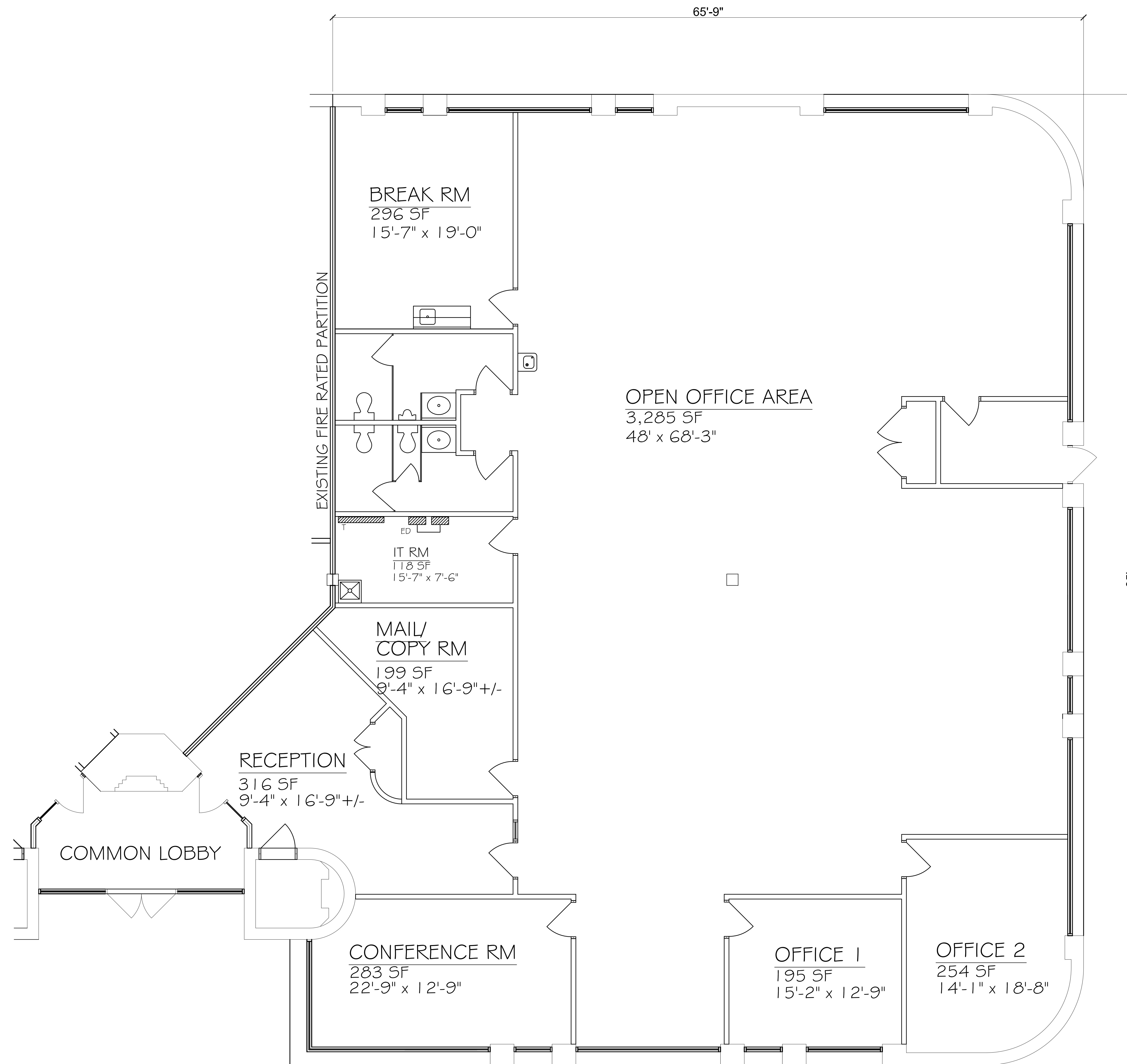

190 Lawrence Bell Drive Suite 104 | Amherst International Park | Amherst, New York

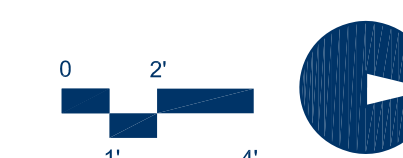

Key Plan 

