

THE HIVE

Unique Grade-A office
space in the heart of
the Northern Quarter

51 Lever St,
Manchester M1 1FN



Contents

04	Introduction to The Hive
08	Full Refurbishment
12	Sustainability
14	The Arcade
16	Available Space and Floorplans
18	The Northern Quarter
22	Contact

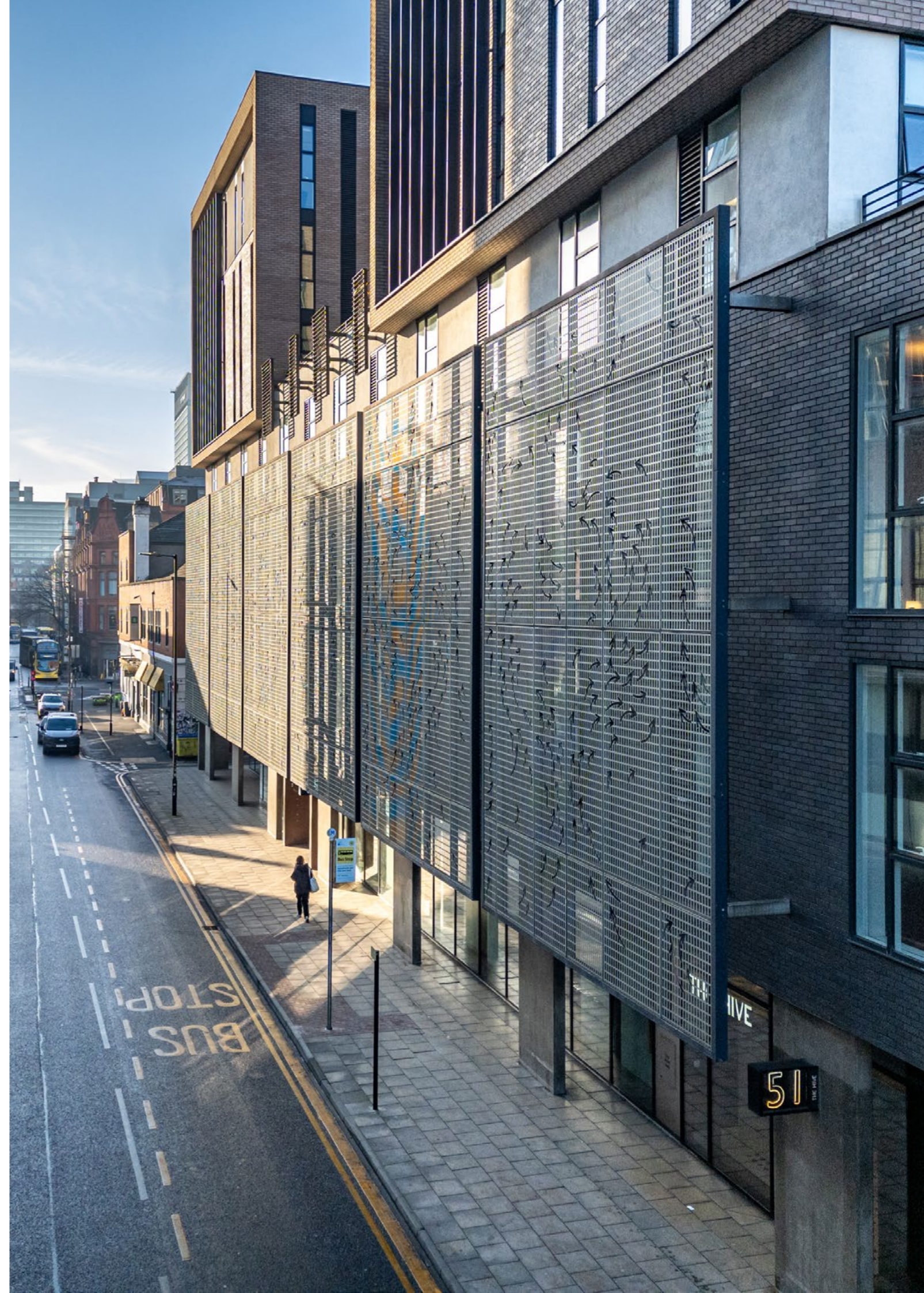

Introduction to The Hive

The Hive is a unique Grade 'A' office building in the heart of Manchester's thriving Northern Quarter. Designed by 5plus Architects, who are also one of the occupiers, The Hive is one of Manchester's greenest and most energy efficient buildings. The building won the prestigious British Council for Offices Award for Best Commercial Workspace in the North in 2011.

The 80,000 sq ft building is home to some of Manchester's most creative and innovative businesses, while the ground floor arcade provides popular F&B and amenities which are enjoyed by tenants and visitors from across the city.

The building was acquired by Grosvenor in 2021. A privately-owned international property company with a track record of over 340 years, Grosvenor develop, manage and invest with a purpose of improving property and places to deliver lasting commercial and social benefit.





THE ARCADE

THE HIVE

47

THE HIVE

49

51

Full Refurbishment

As the new owner of The Hive, Grosvenor have undertaken a substantial refurbishment of the building. The aim of the refurbishment is to reposition the building by upgrading the ground floor receptions, cycle facilities, lift lobbies, communal WCs and fully refreshing the vacant office suites.

Incognito were the interior designers responsible for the transformation of the space. An exciting new interior design and branding studio, Incognito deliver high profile projects for global occupiers and funds on a national and international scale. The studio offers highly experienced award-winning designers working on a range of services from workplace consultancy right through to launch strategies and marketing collateral for new building environments.

The updates make a statement of intent in the city and fully embed the Hive within the Northern Quarter.



Quality Cycling Facilities

As part of the building refurbishment, Grosvenor has doubled the size of the cycling storage and changing facilities. The thoughtful design and attention to detail will make for an enjoyable user experience akin to a health club to encourage building occupiers to adopt sustainable travel choices. The new facilities include:



Substantial bicycle storage



6 new showers including an accessible facility and WC



56 lockers plus dedicated drying room



Vanity area with hair dryers and iron



Electric bike charging



Cycle repair station



Sustainability

Natural Ventilation System

The Hive makes use of free, passive, zero energy-use cooling.

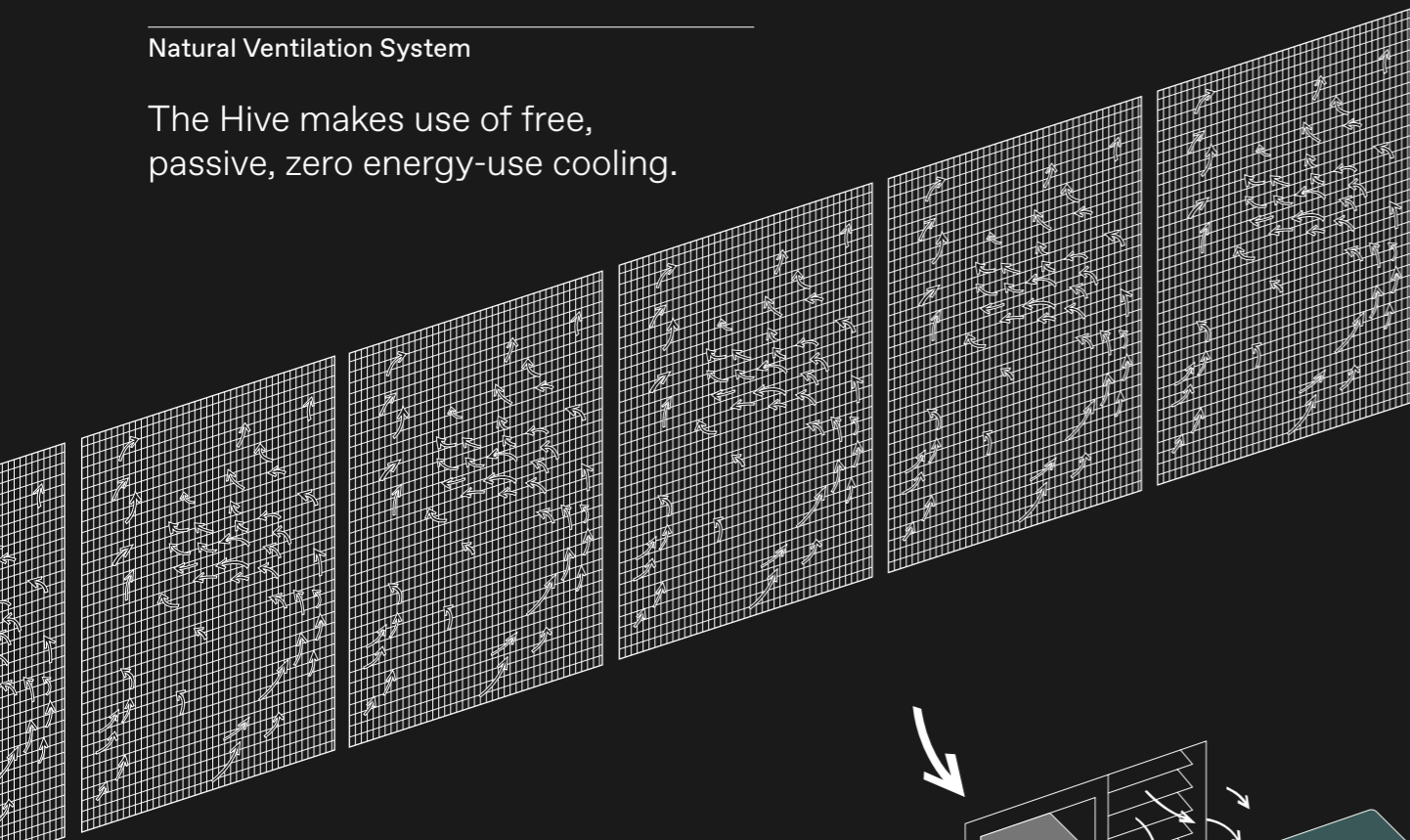

Solar shading
A 45m long façade screen fixed along the southeast face of the building designed to filter sunlight

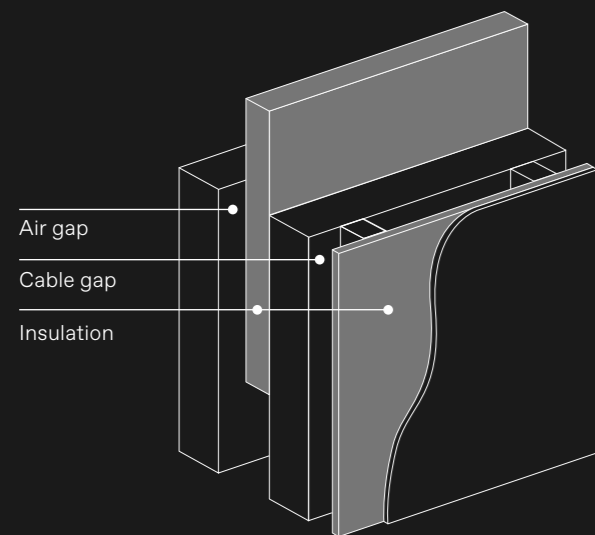

High performance insulation
Over 50% more efficient than standard conservation of fuel and power requirements

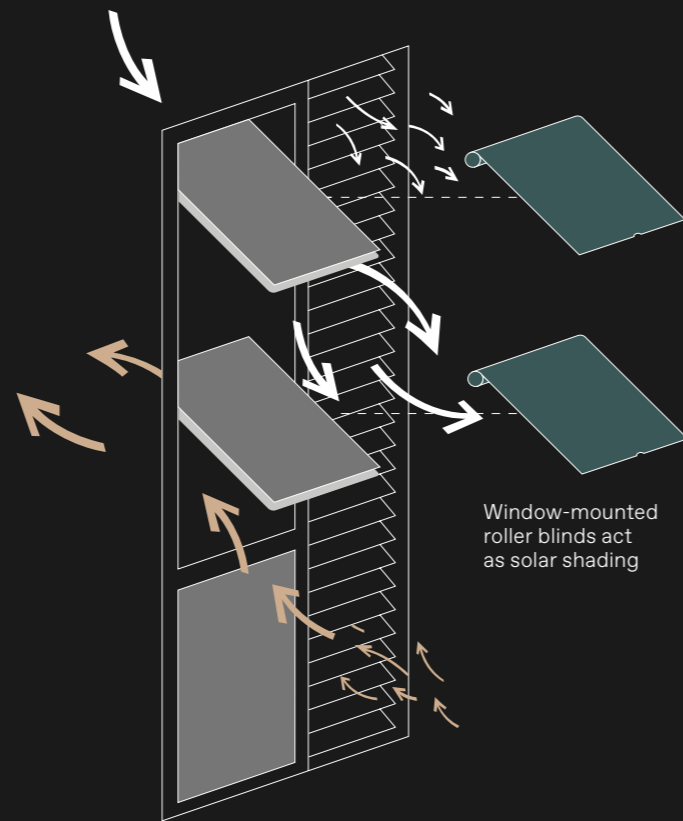

Window-mounted roller blinds act as solar shading

Window design
The openable aspect of the design allows good user control for ventilation. Excellent light with 2.9m floor-to-ceiling design

Motorised louvres
Night cooling dampers open to cool the building at night where appropriate, with weather-resistant ventilation

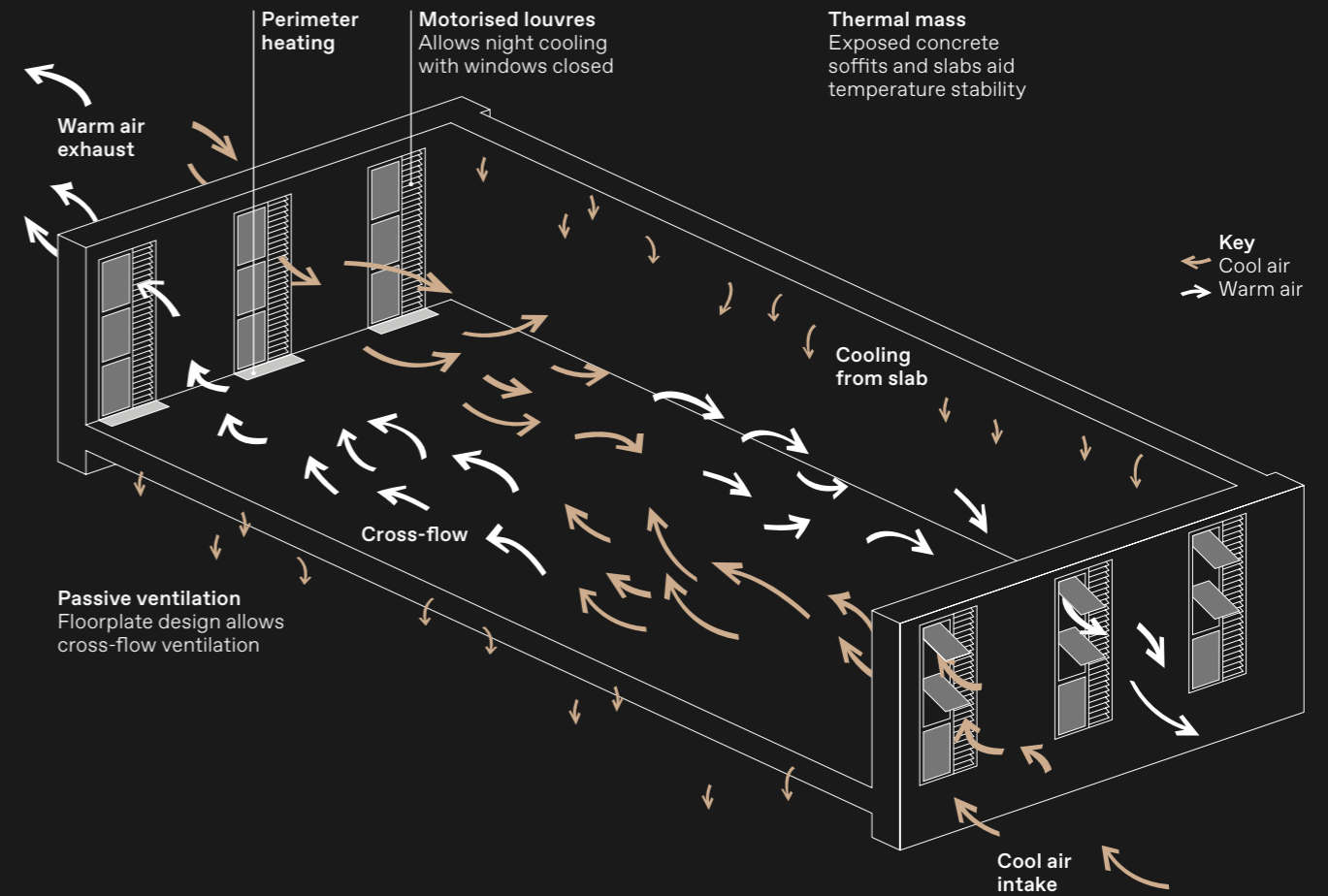

Green Credentials

BREEAM rating 'Excellent': Industry certificate measuring efficiency, building design, management and sustainability

'Gold badge' provision of recycling and environmental management facilities (ISO14001)

Energy procured from renewable sources

Living roofs

Brown and green planted roofs enhance the local ecology

Low water use measures

Self-closing taps, leak detection facilities and low flow fixtures and fittings

Energy efficient lighting

Intelligent lighting management system with zone control, presence detection and daylight dimming

Energy efficient utilities

Wessex Modular Condensing Boilers (latest technology boilers)

Promotion of sustainable transport

Spacious and secure internal bike store with showers and dry room changing facilities to be delivered as part of the refurbishment works

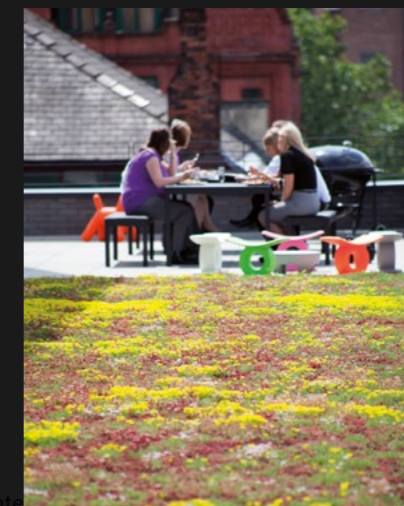

The Arcade

The ground floor arcade provides popular F&B and amenities enjoyed by tenants and visitors from across the city.



Available Space

Cat A

There is limited space available at the Hive. Units are provided to a Cat A specification to allow you to fit out your office to your own requirements and design.

Fifth Floor 1,761 sq ft

● Available spaces ● Service and access areas ● Occupied spaces

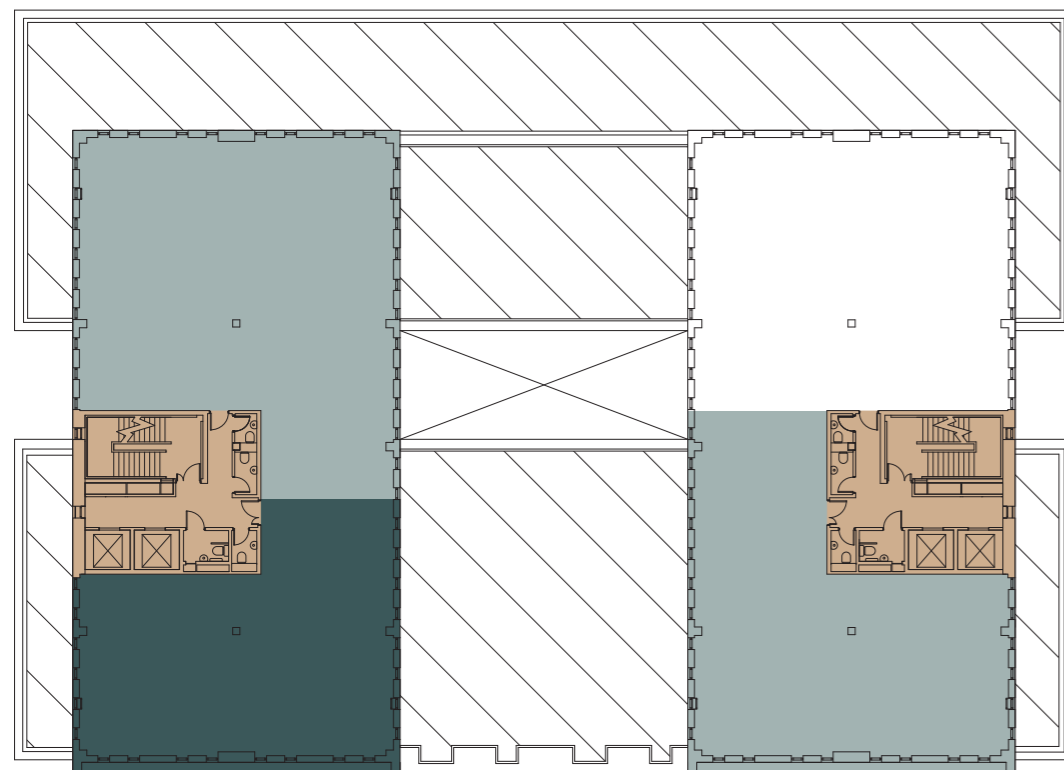

Fifth Floor





Fourth Floor (Fitted suite) + Terrace (under offer) 1,485 sq ft

Fifth Floor (Fitted suite) 2,368 sq ft

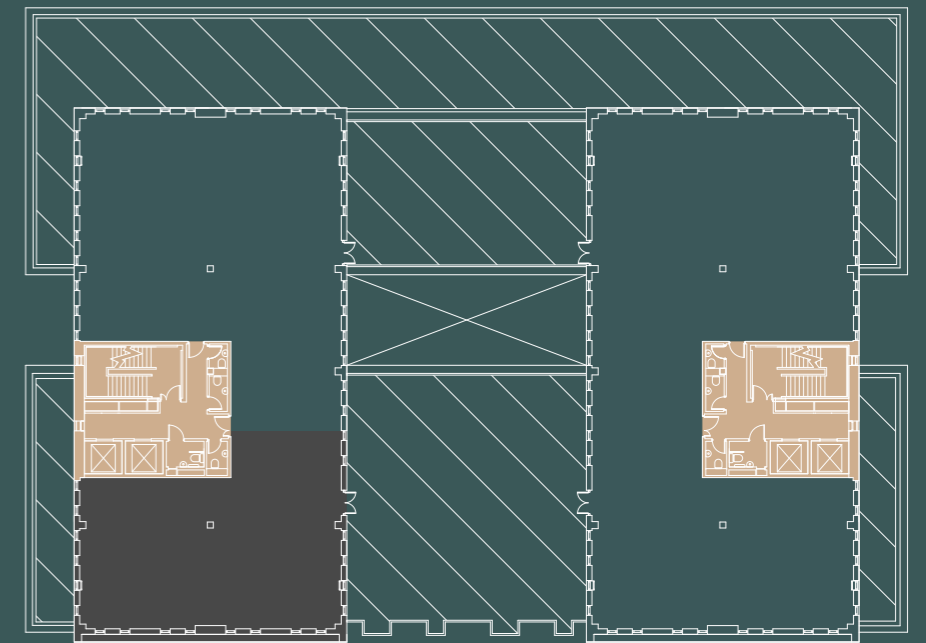

Fourth Floor

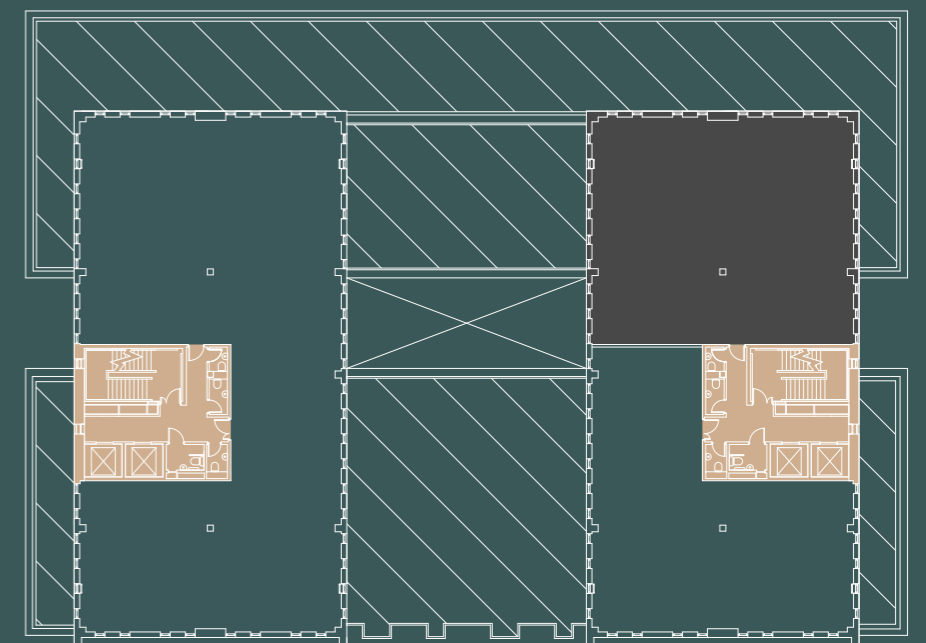
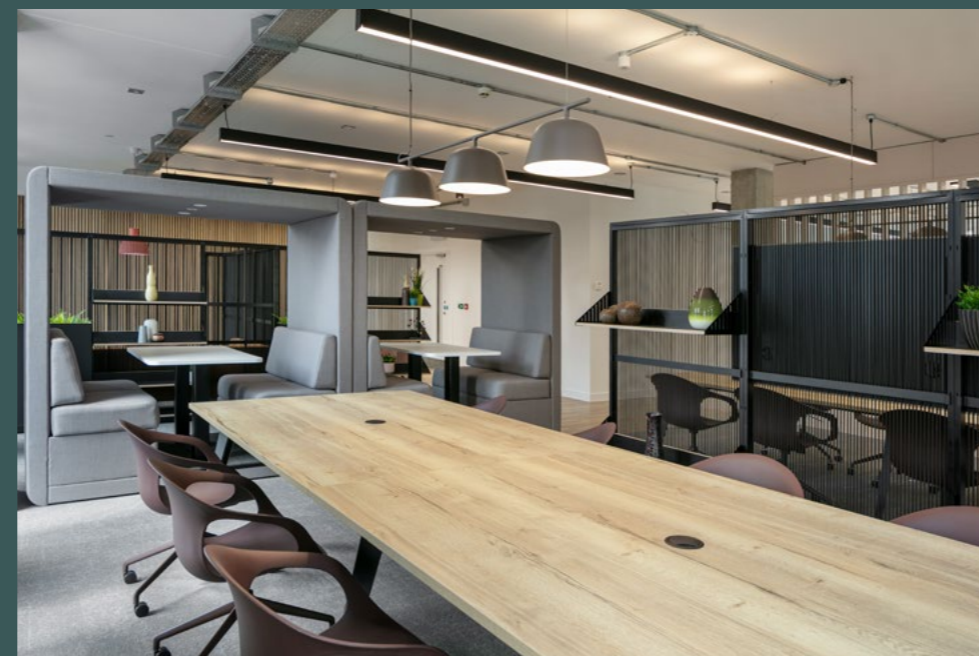

Fifth Floor



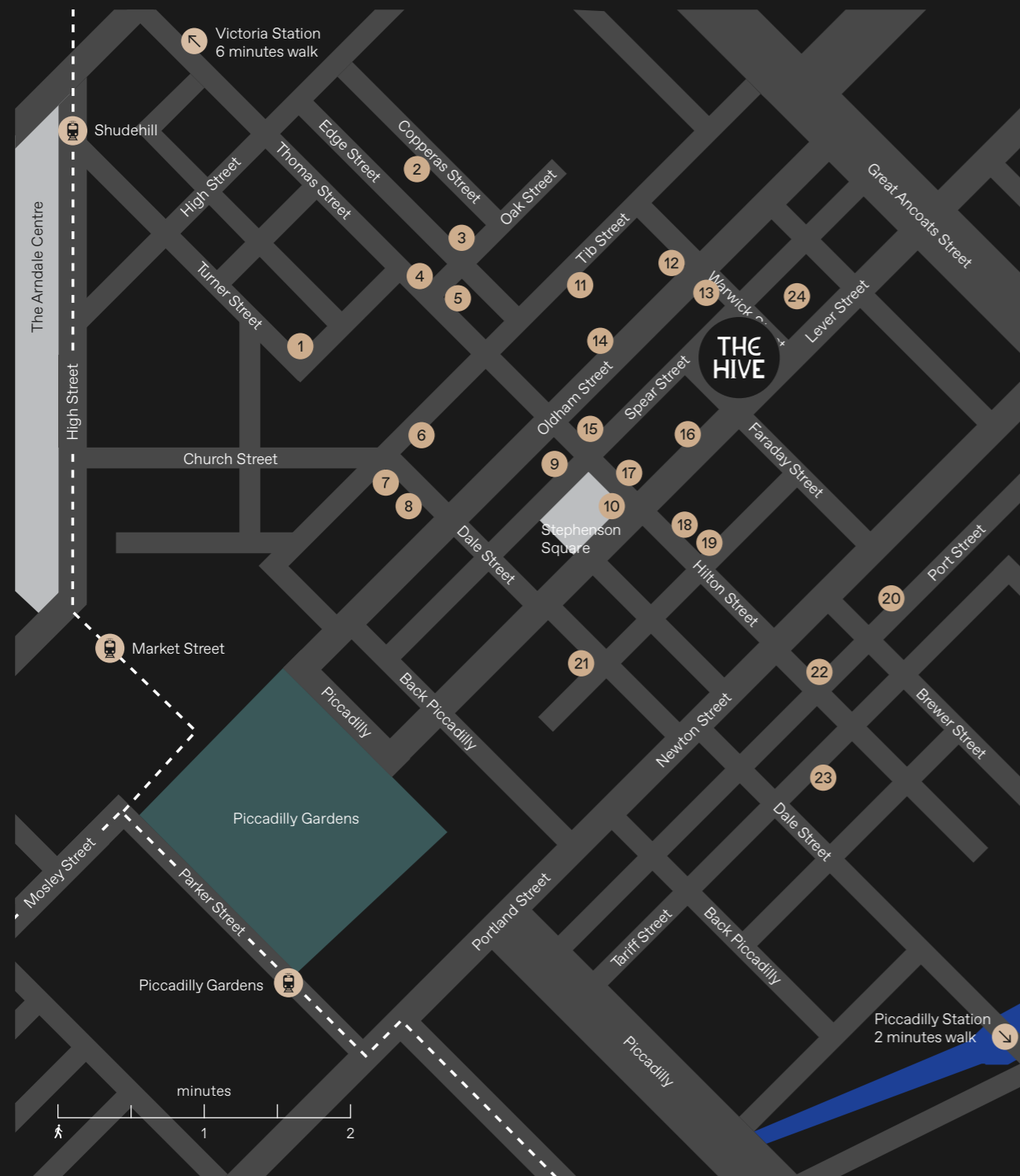







The Northern Quarter



- | | | |
|----------------------|----------------------|----------------------------|
| 1 SoLita | 9 Soup Kitchen | 17 Eastern Bloc Records |
| 2 Common Bar | 10 Fred Aldous | 18 Quarter House |
| 3 Home Sweet Home | 11 Tib Street Tavern | 19 Kraak Gallery |
| 4 Rivet & Hide | 12 Gullivers | 20 Port Street Beer House |
| 5 Oi Polloi | 13 The Castle Hotel | 21 2022 NQ |
| 6 North Tea Power | 14 Matt & Phreds | 22 Crown and Anchor |
| 7 Black Dog Ballroom | 15 Koffee Pot | 23 Northern Monk Refectory |
| 8 Afflecks | 16 7 Sins | 24 Companio Bakery |



Excellent transport links

- Piccadilly Gardens Bus Station   5 minutes
- Shudehill Metrolink & Bus Depot    6 minutes
- Manchester Piccadilly Station    10 minutes
- Manchester Victoria Station    10 minutes



Manchester's Northern Quarter is known for its thriving independent shops, cafés, bars, clubs, art galleries and restaurants. There's also something new and original happening – surprising art installations, launch parties and the odd Hollywood film being shot on the streets.

The Hive is just ten minutes on foot from Piccadilly Station and five minutes from the Metrolink and Bus interchange at Piccadilly Gardens, providing great public transport links across the region and the UK.





Edwards & Co

Ed Keany
07734 229 202
ed@edwardsandco.com

Richard Dinsdale
07801 294 770
richard@edwardsandco.com

savills

Daniel Barnes
07870 186 410
dbarnes@savills.com

Oliver Luckman
0161 602 8218
oliver.luckman@savills.com

OBI

Andrew Cowell
acowell@obiproperty.co.uk
07584 990 976

Edwards & Co, Savills, OBI and Grosvenor gives notice to anyone who may read these particulars as follows: 1. These particulars are prepared for the guidance only of prospective purchasers. They are intended to give a fair overall description of the property but are not intended to constitute part of an offer or contract. 2. Any information contained herein (whether in the text, plans or photographs) is given in good faith but should not be relied upon as being a statement or representation of fact. 3. Nothing in these particulars shall be deemed to be a statement that the property is in good condition or otherwise nor that any services or facilities are in good working order. 4. The photographs appearing in this brochure show only certain parts and aspects of the property at the time when the photographs were taken. Certain aspects may have changed since the photographs were taken and it should not be assumed that the property remains precisely as displayed in the photographs. Furthermore no assumptions should be made in respect of parts of the property which are not shown in the photographs. 5. Any areas, measurements or distances referred to herein are approximate only. 6. Where there is reference in these particulars to the fact that alterations have been carried out or that a particular use is made of any part of the property this is not intended to be a statement that any necessary planning, building regulations or other consents have been obtained and these matters must be verified by any intending purchaser. 7. Descriptions of a property are inevitably subjective and the descriptions contained herein are used in good faith as an opinion and not by way of statement of fact. Published June 2025.
Reference: 2506009 jamesjames.design

THE HIVE

 @TheHiveManc
The Hive
Lever Street
Manchester M1 1FN
www.thehivenq.com

 GROSVENOR
www.grosvenor.com